

NOTICE:

Heat Seal Machine Equipped with Pro-Con

Dear Valued Customer,

This NOTICE is to remind you that the machine you recently purchased is equipped with a feature called Pro-Con. Pro-Con is a device that exposes the garment label to the optimum heat sealing conditions. It does this by monitoring the upper platen surface temperature and makes dwell time adjustments automatically based on the garment type and weight.

The heat control temperatures have been preset at the factory. The only requirement needed to operate the machine is to hook up the air, set the air pressure on the air gauge to the desired level and turn on the power. ***Before making any changes to the temperature controllers or the Pro-Con, it is recommended that you consult the factory.***

Regarding maintenance, ***it is imperative that upper platen teflon is kept in good condition and that the surface probe is attached properly.*** Explicit instructions on attaching the surface probe are noted in the manual. See Surface Probe Attachment.

NSC HEAT SEAL MANUAL

MODEL NUMBER HS159-5LFP ORIGINAL



Natmar Services Company

139 Beattie Street • P.O.Box 6743 • Syracuse, NY 13217

Toll Free 800-798-8206 • Local (315) 445-2419 • Fax (315) 445-8046

Visit us on the web at www.natmar-nsc.com



Innovators of the Future

Natmar Services Company

139 Beattie Street • P.O. Box 6743 • Syracuse, NY 13217

Toll Free 800-798-8206 • Local (315) 445-2419 • Fax (315) 445-8046

Warranty For Heat Seal Machine

Natmar Services Company, Syracuse, New York ("Seller") warrants this Heat Seal machine to be free from defects in material and workmanship under normal use and service. Any part which proves to be defective in material or workmanship within one year of the date of original purchase for use, will be repaired or replaced, at Seller's option, free of service or labor charges, with a new or functionally operative part. Seller's liability under the Warranty shall be limited to repairing or replacing at its own factory or through an authorized service distributor or dealer, material which is determined by Seller to have been defective in manufacture and upon which a claim has been made by the original purchaser or user to Seller (or an authorized distributor or dealer) within the warranty period. An authorized officer of Seller will honor claims under this Warranty only upon written approval. Approved return of parts or products will be on a prepaid transportation charges basis only. Claims under this Warranty will be honored only upon Seller's determination that the claim is covered by this Warranty, and Seller shall incur no obligation under this Warranty prior to such determination. This Warranty does not apply: (1) To any machinery or equipment which has been altered or repaired, except by Seller or its authorized representatives, or (2) to any machinery or equipment which has been subject to misuse, negligence, or accident, including, without limitation, use an operation of such machinery or equipment while parts are loose, broken, out of order, or damaged by the elements. Parts replaced under this Warranty are warranted only through the remainder of the original Warranty. Any and all claims for warranty service must include such information as Seller designates, and shall include specifically the serial number of each unit (if appropriate).

The foregoing shall constitute the sole and exclusive remedy of any using purchaser and the sole an exclusive liability of Seller in connection with this product. THIS WARRANTY IS IN LIEU OF ALL OTHER WARRANTIES, EXPRESS, IMPLIED OR STATUTORY, INCLUDING BUT NOT LIMITED TO, ANY WARRANTY OF MERCHANTABILITY OR FITNESS AND ALL OTHER OBLIGATIONS OR LIABILITIES OF SELLER, INCLUDING ANY TORT LIABILITY, FOR NEGLIGENT DESIGN OR MANUFACTURE OF THIS PRODUCT, OR OTHERWISE. It is expressly agreed that Buyer shall not be entitled to recover any incidental or consequential damages, as those terms are defined in the Uniform Commercial Code, and that Buyer shall have no right of rejection or of revocation of acceptance of any part or of revocation of acceptance If any part or all f the goods covered hereby.

Natmar Services Company reserves the right to make changes in design and changes or improvements upon its product without imposing any obligation upon itself to install the same upon its products previously manufactured.

1. UNPACKING AND INSTALLATION

1-1 CHECKING SHIPMENT

- A. The machine is shipped fully assembled
- B. Check items received against item on the packing slip. Thoroughly check the machine for any damage that may have occurred in transit. Advise the carrier of any damage or missing components within seven (7) days.

1-2 NOTES, CAUTIONS AND WARNINGS

Notes, cautions and warnings are used throughout the manual to emphasize important and critical instructions.

NOTE: A note is used to emphasize operation procedures, practices, etc...essential for proper use.

CAUTION: A caution is used to emphasize operating procedures, practices, etc., which if not strictly observed may result in damage to the machine.

WARNING: A warning is used to emphasize operation procedures, practices, etc., which if not strictly followed may result in person injury or loss of life.

1-3 INSTALLATION

The machine may be installed on any level surface capable of supporting its weight. It should be located at least 12 inches from the closest object for ease of maintenance, and should be set back at least 6 inches from the edge of the bench or table on which it rests. Consistent with these requirements, the machine may be further arranged for maximum operator comfort and efficiency.

1-4 AIR SUPPLY

Connect air to the air filter, located at the rear of the machine. Set machine at a minimum of 60-PSI incoming pressure.

CAUTION: Use clean dry air only. The machine air filter will remove normal amounts of condensation and foreign matter only. If the air service contains an excessive amount of condensation and foreign matter, a trap, filter and/or dehydrator should be installed in the air service line, upstream from the machine.

ELECTRICAL REQUIREMENTS

The current is supplied to the machine through the power cord, which may be plugged into any power source that has 110-120 VAC 60HZ receptacles. These machines have the following requirements:

	<u>Requirement (Amps)</u>	<u>Fuse Size (Amps)</u>
Thermoset II 4" X 6" Heads	9	10 3X4-7Amp
Thermoset II 5 " X 7" Head	10	10 3X4-7 Amp
Twin Seal	13	15
Easy Seal	13	15

NOTE: There is an option for a 240 VAC 50 HZ source machine which utilizes a breaker instead of a fuse.

WARNING: ELECTRICAL GROUNDING INSTRUCTIONS

The power supply cord has a 3-prong grounding for your personal safety. It must be plugged into a mating 3-prong grounding type wall receptacle, grounded in accordance with the National Electrical Code and local codes and ordinances.

DO NOT REMOVE THE GROUND PLUG

DO NOT USE AN EXTENSION CORD

2. OPERATION

Before starting the machine, it is important that the operating personnel become thoroughly familiar with the operating instructions. The major assemblies of the machine are the upper and lower heating heads. The upper head is lowered and raised by an air cylinder and the lower head remains stationary.

2-1 AIR REGULATOR

Loosen screw in center of knob. Turn knob clockwise to increase, Counterclockwise to decrease air pressure to machine. Machine will operate normally at 80 lbs. pressure. Lock screw after adjusting.

2-2 AIR PRESSURE GAUGE

The air pressure gauge indicates the air pressure inside the machine. The adjustable air pressure regulator positioned just below the gauge controls the reading on the gauge and the pressure applied to the heating heads. Turning the regulator clockwise increases the pressure up to the line pressure that is supplied to the machine.

2-3 TIMER

The timer adjusts the amount of time that the heating head remains in the down position. The desired time is set by:

- A. Remove the transparent cover by pulling up and out.
- B. Pressing the small buttons under each digit causes the digit to be decreased by one. The colored digits to the right side represent digits to the right of the decimal point. That is tenths, hundredths, etc.

2-4 POWER ON/OFF SWITCH

Controls all electric power to the machine. The switch setting can be determined from the position on the rocker. A signal light to the lower right of the power switch indicates the presence of electric power.

2-5 EMERGENCY RELEASE

Pressing the large red button will stop eth machine cycle and return the top-heating head to its upper position.

2-6 COUNTER

This counter counts only if the head goes down and the set time has elapsed in its entirety. Pressing the button located on the left side of the counter may reset the counter.

2-7 DUAL GREEN START BUTTONS

Emergency Release Bar-this bar, which surrounds the top heating head, is a safety touch switch. If the hand or any other part of the body touches it during the machine's cycle, the upper head will immediately rise to its upper position. It will not lower again until both start buttons are pressed simultaneously.

2-8 THERMOSTATS (THERMOSET I ONLY)

The heat control consists of an adjustable thermostat in each heating head. The ON/OFF switch energizes each thermostat, which calls for the heat to the head and turns on the indicator light. When the proper temperature is reached, the thermostat stops heating and turns off the indicator light, calling for more heat only when necessary to maintain operating temperature.

NOTE: When the thermometer is cool, check that the indicator needle points straight down. If it does not, the thermometer is defective and should be replaced.

- A. With the machine ON, wait until the indicator light goes out and read the thermometer. The heating head is set at that temperature.

WARNING: Do not touch the thermometer stem after measuring temperatures. A burn could result.

- B. To adjust the temperature, turn the thermostat adjustment screw clockwise to increase temperature, counterclockwise decreases temperature.

CAUTION: Turn the adjustment screw only in small increments and DO NOT allow it to remain in the fully clockwise position. The extreme heat that results, will damage the machine.

- C. When you make a heat adjustment, wait for the head to reach the new temperature. The indicator lights will show when this has occurred. Read the thermometer and adjust further if necessary.

CAUTION: DO NOT set or allow machine to operate at temperatures over 500 ° F.

2-9 DIGITAL TEMPERATURE CONTROL (THERMOSET II ONLY)

There are two controllers located on the right side of the cabinet under the timer.

NOTE: The controller will not allow the temperature of the respective head to rise above 500° F. For more detailed information on digital controllers, see next three (3) pages (Thermoset II manual only).

3. HEAT SEALING

3-1 GENERAL

This machine utilizes heat and pressure applied for a controlled length of time to perform the following operations:

- A. To bond tape, film, patches, emblems, and other heat sealable materials to Compatible fabrics.
- B. To remove heat-bonded material from fabric.
- C. To remove emblems sewn on with nylon thread.
- D. To apply heat set transfers.
- E. For touch up pressing
- F. Other operations requiring heat and pressure.

3-2 OPERATING INSTRUCTIONS

Sequence of actions:

- A. Place the article on top of the bottom heating head. Place the tape or patch, adhesive side down, on top of article. Arrange the work in the exact position you wish it to be bonded, center on the head. Apply tension to the article to avoid wrinkles being set in by heat.
- B. Remove hand and fingers from the heating head area.
- C. Depress the start buttons simultaneously. (the top heat will automatically descend upon the lower head and press the articles in between for the preset amount of time. The top heating head will then rise automatically in its original position).
- D. To separate bonded material, pull apart the articles, using tweezers, after the top head rises. The materials are too hot for bare hands. Use dwell times the same as the ones used to apply the articles.

4. PERIODIC MAINTENANCE

Machine malfunctions and damage to articles being processed can be minimized by performing the periodic inspections below. These inspections should be made daily.

4-1 INSPECTION PROCEDURE

- A. Check temperature, pressure and time settings and reset if they have been changed.
- B. Check external airline filters and traps. Clean out as required.

Periodically, the filter element and bowl should be removed and cleaned. To remove the filter element, the filter must be depressurized and the bowl removed. The bowl should be washed with soapy water.

WARNING: Never disassemble unit under pressure. Relieve all pressure before disassembling.

The filter element can be washed in the same solution as the bowl. After washing, dry air filter element by blowing compressed air fro inside outwards. Replace and reassemble bowl.

CAUTION: Never wash transparent bowls with gasoline or any fluids containing acetone, ethyle acetate, ethylene, dichloride, toluene, etc...which will damage bowl.

- C. Inspect teflon head covers for damage or wear. Replace as necessary.
- D. Check safety bar for damage and for proper operation. (Thermosets Only).
- E. Clean the machine.

The machine should be thoroughly dusted at the end of each day's operation.

NOTE: Occasionally, adhesive, lint, etc., may build up on the underside of the heating head and platen cover. This build up can be removed by starting the machine and wiping the build up off with a cloth after heating heads are warm.

WARNING: Always disconnect the power plug from the outlet and the air line before performing repairs.

THE USE OF SYNTHETIC OILS IN THIS MACHINE WILL HAVE A NEGATIVE EFFECT ON THE "O" RINGS IN THE AIR VALVE CAUSING THE MACHINE TO BECOME INOPERABLE.

WE RECOMMEND THAT NO OIL BE PLACED INTO THE AIR SYSTEM OF THIS MACHINE.

5. TROUBLE SHOOTING
STANDARD MODELS ONLY

<u>Trouble</u>	<u>Possible Cause</u>	<u>Corrective Action</u>
Head will not descend	<ul style="list-style-type: none">• Defective start/stop witch• Timer defective• Top head not in position• Defective anti tie down relay• Defective air valve• Defective touch control board	<ul style="list-style-type: none">• Replace switch or adjust start switch• Replace timer or relay• Move head to full right of left position• Check for faulty regulator• Replace valve• Replace cylinder• Reduce touch sensitivity-by-bass touch board, call Natmar for instructions
Head will not rise	<ul style="list-style-type: none">• Defective timer or relay• Defective valve	<ul style="list-style-type: none">• Replace timer or relay• Replace valve
Head descends and raises too slow	<ul style="list-style-type: none">• Improper air pressure	<ul style="list-style-type: none">• Check and adjust the air regulator
Head will not remain down	<ul style="list-style-type: none">• Defective timer• Improper timer setting• Damp clothes• Sensitivity on touch board too high	<ul style="list-style-type: none">• Replace timer or relay• Adjust timer• Reduce sensitivity by turning sensitivity knob counterclockwise
No heat or too much heat at one heating head	<ul style="list-style-type: none">• Defective thermocouple-Easy Seal• Defective temp controller-Easy Seal• Defective heating head• Loose or broken wire connection• Defective head control relay• Defective thermostat-Twin Seal	<ul style="list-style-type: none">• Replace thermocouple• Replace temperature controller• Replace heating head• Restore wire connections• Replace relay• Replace heating head

5. TROUBLESHOOTING STANDARD MODELS

<u>Trouble</u>	<u>Possible Cause</u>	<u>Corrective Action</u>
Weak Bond	Timer set incorrectly For operation being Performed.	Adjust timer
	Temperature too High or too low	Adjust temperature of heads
	Incorrect air Pressure	Adjust air regulator
	Defective tapes	Call manufacturer or Tapes to obtain suggested Sealing conditions.
Audible air leak or “blow-by” In valve	Defective valve Sticking valve Cylinder “O” ring or Piston cup worn	Replace valve Replace valve Repair or replace air cylinder

Troubleshooting Heat Related Problems & Air Leaks
HS155, HS157, HS159

Head will not descend:

- Check air gauge and air pressure
- Check if timer is operating. If the timer is operating properly, then check the timer with a voltage meter to see if you are getting power out of the timer and to the air valve.
IF YES, then the air valve (part # 2324 or # 2959 on 100 volt machines) is defective.
IF NO, then the timer (part # 2860) is defective.
- Check the touch board (part # 2025). The green light should be “**ON**” and the red light should be “**OFF**” for proper operation. See page titled “installation and use of model 2025 touch board”. If the machine then operates, the board could be defective.
- Check the anti-tie down relay (ATD Relay). The blue plug in device that is located behind the ON/OFF switch. Swap relays to see if problem follows with the relay, if so, replace the anti-tie down (ATD Relay-part # 3300)
- Next, check for voltage on the timing circuit by placing one probe on the terminal strip (part # 1660) where the white wires connect. Carefully place the other probe one at a time on the following:

NC	on the touch control board (part # 2025)
C	on the red stop switch (part # 2823)
RED	wires on the terminal strip (part # 1660)
C	on the single start switch (part #2823)
C	on the double start switch (part # 3305) *

*There are two poles; power should be on one pole at time, alternating when the single start button is pushed.

Unplug the ATD Relay (part # 3300). There should be power on #3. Press both green buttons and there should be power on #2 & #8 (may be helpful to have another person assist in pressing buttons.) Plug the ATD Relay back in and check for power at #7 on the timer (part # 2860)

- By now the defective part should have been located. If not, call Natmar Services Company @ 800-798-8206 for assistance.

Pro-Con equipped machines

- There should be a 15°- 20° difference in the SV (Set Value – green display) and PV (Process Value – red display). Greater variances will cause the machines to be inoperable. Adjust the temperature of the upper platen and the SV of the Pro-Con accordingly.
- Pro-Con controller displays: S.Err. This is an indication that the Pro-Con controller is not receiving input from the probe. Inspect probe for breaks. Insure that probe plugs are secure.
- Pro-Con PV display (red) flickers. Inspect teflon – probe not secure against surface of upper platen. See probe attachment drawing in manual.

Head will not rise:

- Turn the machine off by moving the ON/OFF rocker switch (part # 2150) to the **OFF** position. If the head remains down, then the Air valve (part # 2324) is defective.
- Check the timer for proper setting. Make sure the last digit is on the **S** for seconds.

Head will not remain down:

- Check the timer for proper setting. Make sure the last digit is on S for seconds.
- Make sure garments are dry. Wet garments will trigger the safety bar feature, preventing the head from staying down.
- See page titled "installation and use of model 2025 touch control board" for proper setup and operation of the touch control board. You may have to reset the sensitivity.

No heat on one head:

Thermoset I

- Check the wires to the heating head. Remove wire cover on rear of head to locate problem. Check for voltage between white wire on head and black wire on the thermostat (wire by itself)
- Check between the white wire on the head and the black wire on the head. If there is voltage to the head, the thermostat is bad (part # 21762 or #3370). If there is no voltage, the heating head is bad. Replace heating head (part # 23180).

Thermoset II

- Check to see if heat controller is set at the proper setting. Check **SV** setting on the controller (green number)
- Check to see if heat controller is calling for heat. Out light should be showing **ON**. If heat controller is not **ON** the thermocouple could be bad. Replace thermocouple (part # 2061)
- Switch heat controllers between the two heads. If the problem follows the controller, the controller should be replaced
- Check the voltage between the white wire on the terminal strip and #2 on the solid-state relay (part # 3568). If there is no voltage, replace the relay.
- Remove cover on rear of head and check for voltage between white and black wire. If there is voltage, the head is bad. Replace heating head (part # 23180). If there is no voltage, check for broken wires leading to the heating head.

AUDIBLE AIR LEAK

For air leaking around the shaft of the cylinder:

- Repair Air Cylinder with repair kit #2612A

Audible Air leak out of muffler on air valve

- Air leaks when head is up:
Remove airline from top of air cylinder and check if air is coming out of cylinder. If yes, replace cylinder internal seals (part # 2612B).
- If no, replace air valve (part # 2324)

Air leaks when head is down:

- Unplug machine and shut off air supply to the machine. Remove the airline between air valve and bottom of cylinder (at the air valve #2324). Turn air back on (air will come out of the air-line) and press the small white button on the right side of the air valve. Check for air coming out of the airline while the button is in. If yes, replace the cylinder's internal seals (repair kit #2612B)
- If no, replace air valve # 2324

Counter will not count:





- Counter is battery operated no AC voltage required. Short out 1 and 2 on rear of counter
- If there is no count, replace counter (part # 3303). If the counter doesn't count, check wiring and replace counter relay (part # 2864).

Digital Temperature Control (Thermoset II Only)

The heat controllers located on the right side of the cabinet under the Pro-Con device.

NOTE: The controller will not allow the temperature to be set over 450 ° F

To Change Set Value

- To change set value at the RUN status, push “<<” key
- Push  or  key, then the digit will be shifted step by step.
- Push  or  at the flashing digit, then change the set value.
- Push MD key after setting the set value to be changed. The digit flashing will stop therefore setting the value at the run status.

Touch control board adjustment procedure

1. Check all of the wiring to the Touch board for loose or broken connections.
2. Turn on the machine and allow it to warm up.
3. Remove the touch guard sensor wire from the Sensor input connector.
4. Turn the Sensor detect adjustment screw until the Sensor detect light turns on.
5. Reconnect the touch guard sensor wire to the Sensor input connector. The Sensor detect light should go out.
6. Adjust the Trigger adjustment until the Trigger light turns on when you touch the bar with One finger.
7. Adjust the Delay adjustment so the machine cannot operate until after the sealing iron has returned to Up position.

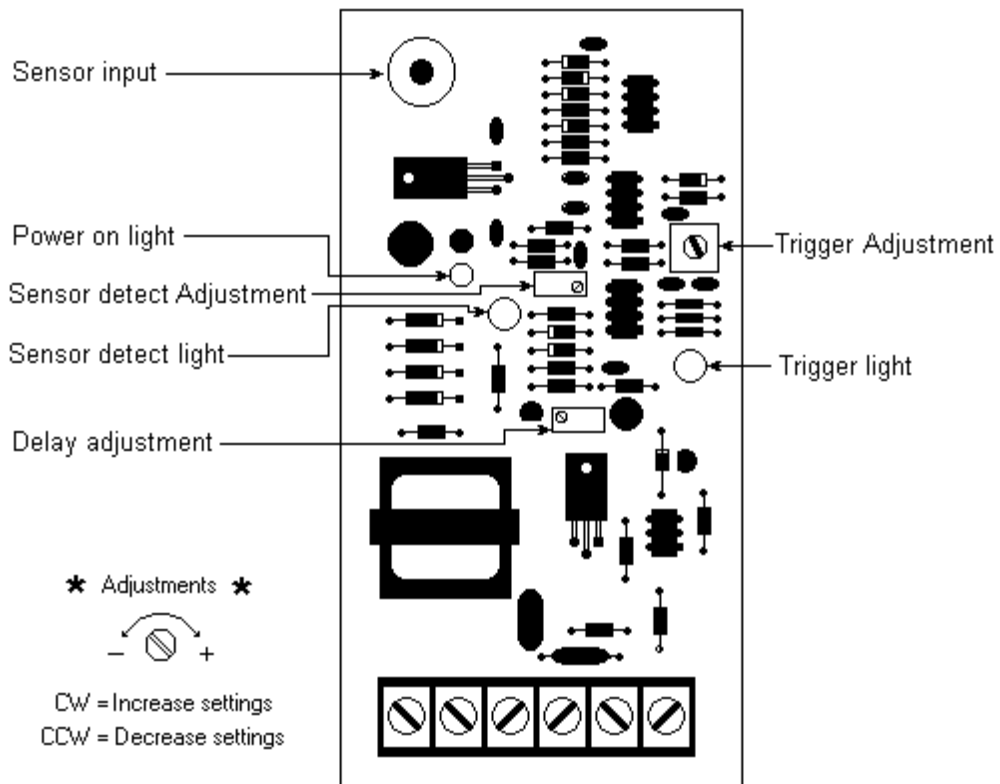



Innovators of the Future

Natmar Services Company

139 Beattie Street • P.O. Box 6743 • Syracuse, NY 13217

Toll Free 800-798-8206 • Local (315) 445-2419 • Fax (315) 445-8046

www.natmar-nsc.com

Delay Timer Safety Feature

This unit is equipped with a delay timer. This circuitry safeguards the operator so that the actuator (either the push buttons or the foot pedal) must be held until the upper head is completely lowered. The operator therefore cannot depress the push buttons, and then move his or her hands under the upper head, which is being lowered. The operator should be particularly careful to keep his or her hands clear of the heating heads when utilizing a foot pedal with this unit.

Would the operator release the actuator before the upper and lower heads have met, the upper head will immediately rise to its home position. When the upper head has risen to the top position, the operator can again depress the actuator and hold it until the upper head lowers completely.



Natmar Services Company

139 Beattie Street • P.O. Box 6743 • Syracuse, NY 13217

Toll Free 800-798-8206 • Local (315) 445-2419 • Fax (315) 445-8046

www.natmar-nsc.com

**Foot Switch Assembly
70134
(Optional)**

At your request, this machine is equipped with the optional foot switch assembly (# 70134)

---NOTE---

PLEASE READ THE WARNING ATTACHED BEFORE PLACING THE MACHINE BACK IN OPERATION.

The foot switch must be attached to the machine before placing the machine in operation. A quick disconnect plug has been provided for your convenience. Plug the foot switch cable into the receptacle located at the right rear of the machine.

Normal operation of the machine would require the operator to push both green buttons simultaneously and hold them in until the head closes completely, and the main timer (#2860) begins to count down. The operation sequence requires the use of both hands and is designed as a safety feature of the machine.

Use of the foot switch overrides the function of the two green buttons and negates this safety feature. The foot switch must also be depressed and held until the heads close completely, and the main timer (#2860) begins to count down.

The safety touch bar is still operational and is the only safety against operator injury.

---WARNING---

For safety reasons, NATMAR Services Company does not recommend the use of the foot switch on this machine.

It is the responsibility of the user to determine the suitability of a foot control and to provide adequate training in the safe operation of the machine.

NATMAR Services Company will not accept responsibility for damage or injury resulting from the use of the foot switch.

FOOT SWITCH W/GUARD
Part No. 70134

MFG.- CONNTROL INTERNATIONAL
ASSEMBLED

CONNTROL #
864-1000-00

CONNTROL # 892-1330-01
FOOT SWITCH W/CORD & PLUG

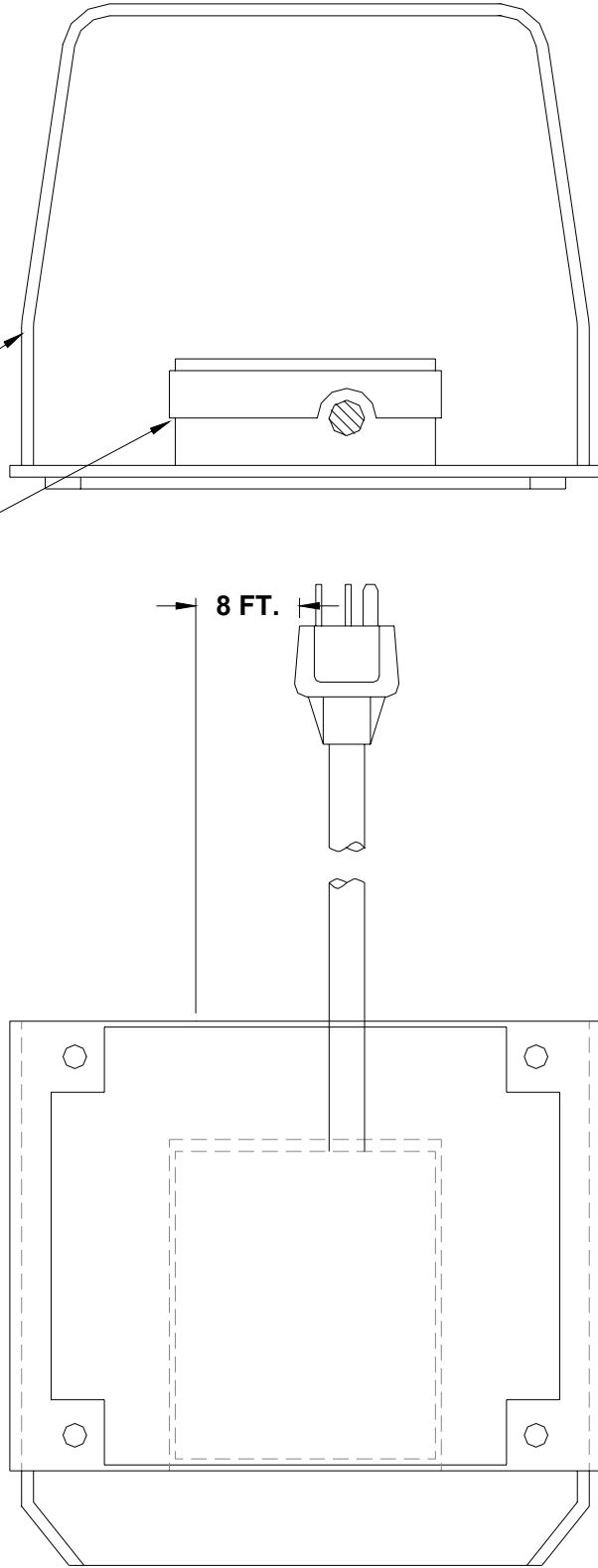

FOR CUSTOMER SERVICE

20056-04 FOOT SWITCH W/CORD & PLUG

20056-05 GUARD

FOR SERIAL # 2148 AND BELOW USE # HA03
FOR SERIAL #2149 AND ABOVE USE # 70134

POWER INPUT CIRCUIT

Part No. 70079

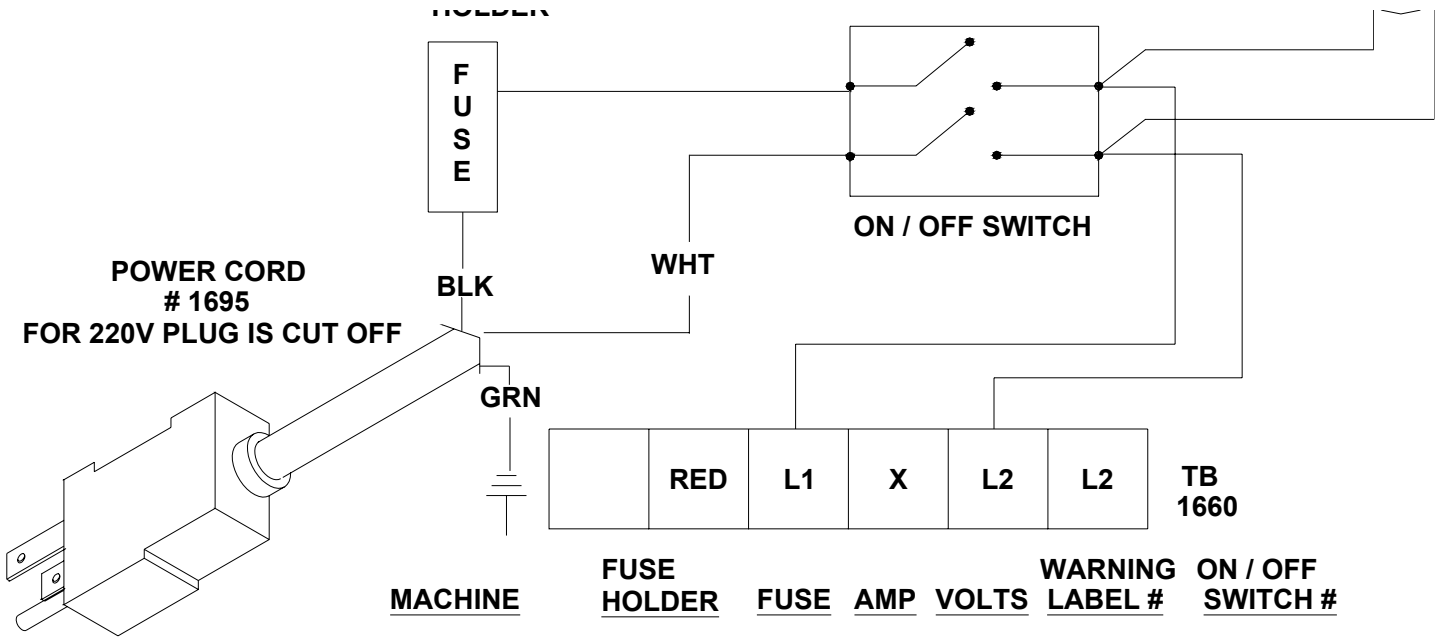

<u>MACHINE</u>	<u>FUSE HOLDER</u>	<u>FUSE</u>	<u>AMP</u>	<u>VOLTS</u>	<u>WARNING LABEL #</u>	<u>ON / OFF SWITCH #</u>
<u>HS155-1 OR (-2)</u>	<u>20081-18</u>	<u>1735</u>	<u>15</u>	<u>120V</u>	<u>46083</u>	<u>2150</u>
<u>HS156-1 OR (-2)</u>	<u>9696</u>	<u>1734</u>	<u>10</u>	<u>240V</u>	<u>70098</u>	<u>2150</u>
<u>HS157-1 OR (-2)</u>	<u>20081-18</u>	<u>1735</u>	<u>15</u>	<u>120V</u>	<u>46083</u>	<u>2150</u>
<u>HS158-1 OR (-2)</u>	<u>9696</u>	<u>1734</u>	<u>10</u>	<u>240V</u>	<u>70098</u>	<u>2150</u>
<u>HS159-1 OR (-2)</u>	<u>9696</u>	<u>1734</u>	<u>10</u>	<u>120V</u>	<u>70098</u>	<u>2150</u>
<u>HS160-1 OR (-2)</u>	<u>9696</u>	<u>1741A</u>	<u>5</u>	<u>240V</u>	<u>46068</u>	<u>2150</u>
<u>HS155-5</u>	<u>9696</u>	<u>1734</u>	<u>10</u>	<u>120V</u>	<u>70098</u>	<u>2150</u>
<u>HS156-5</u>	<u>9696</u>	<u>1741A</u>	<u>5</u>	<u>240V</u>	<u>46068</u>	<u>2150</u>
<u>HS157-5</u>	<u>9696</u>	<u>1734</u>	<u>10</u>	<u>120V</u>	<u>70098</u>	<u>2150</u>
<u>HS158-5</u>	<u>9696</u>	<u>1741A</u>	<u>5</u>	<u>240V</u>	<u>46068</u>	<u>2150</u>
<u>HS159-5</u>	<u>9696</u>	<u>1741</u>	<u>7</u>	<u>120V</u>	<u>70097</u>	<u>2150</u>
<u>HS160-5</u>	<u>9696</u>	<u>1741A</u>	<u>5</u>	<u>240V</u>	<u>46068</u>	<u>2150</u>
<u>HS159-10</u>	<u>20081-18</u>	<u>70131</u>	<u>20</u>	<u>120V</u>	<u>70132</u>	<u>70138</u>
<u>HS160-10</u>	<u>20081-18</u>	<u>1735</u>	<u>15</u>	<u>240V</u>	<u>46083</u>	<u>2150</u>

PNEUMATIC DIAGRAM 3" BORE CYLINDER
Part No. 32335 1 of 2

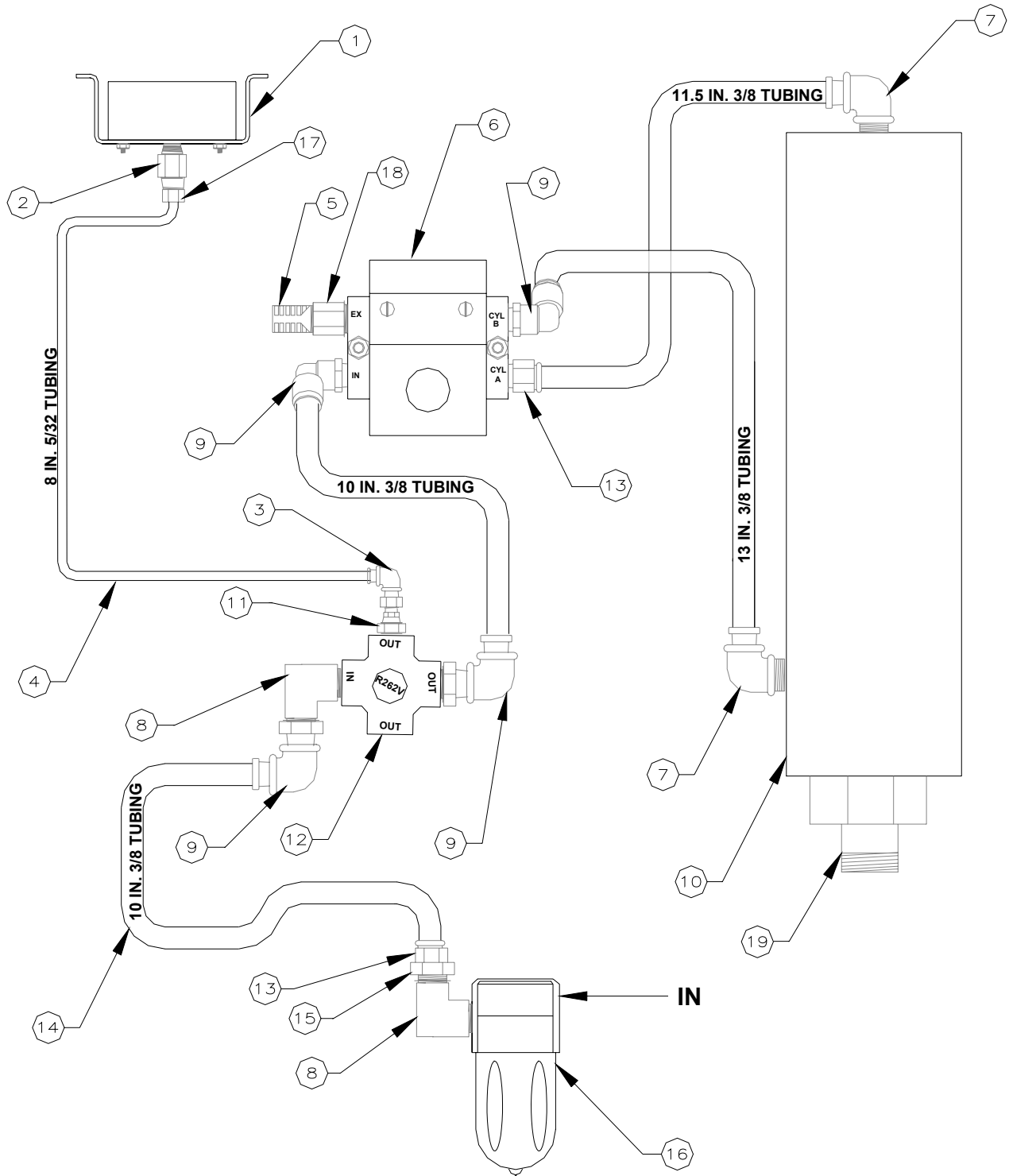

BILL OF MATERIAL
PNEUMATIC DIAGRAM 3" BORE CYLINDER
Part No. 32335 2 of 2

ITEM	DESCRIPTION	QTY.	PARTNUMBER
1	AIR PRESSURE GAUGE (1) 21983	REF.	SEE DWG.70129 # 10
2	REDUCING COUPLING	1	20152
3	ELBOW FITTING	1	21934
4	5/32" TUBING (SMALL)	1 FT.	1871
5	SPEED CONTROL MUFFLER (1) 2339	REF.	SEE DWG. 70089 #11
6	AIR VALVE (1) 2324	REF.	SEE DWG. 70089 # 6
7	MALE ELBOW (2) 1938	REF.	SEE DWG. 70089 # 3
8	STREET ELBOW	1	1598
9	ELBOW 3/8 TUBE x 1/4 MPT REF. DWG.# 70089 #4	4	22015-34
10	BIMBA AIR CYL. 3"BORE,7" STROKE (1) 3371	REF.	SEE DWG.70089 # 1
11	BRASS BUSHING 1/4 NPT x 1/8 FPT	1	20114
12	AIR REGULATOR W/MOUNTING NUT (1) 20066	REF.	SEE DWG. 70129 # 11
13	CONNECTOR 3/8" TUBE x 1/4 MPT REF.DWG.70089 # 5	2	20107
14	3/8" TUBING (LARGE)	4 FT.	9463
15	HEX BRASS LOCK NUT 1/4 NPT	1	21945
16	AIR FILTER (1) 20078	REF.	SEE DWG. 70129 # 36
17	STRAIGHT FITTING	1	21936
18	BRASS ADAPTER 1/4 FPT x 1/4 MPT (1) 20113	REF.	SEE DWG.70089 # 10
19	1 1/2-12 MOUTING NUT (1) 3365	REF.	SEE DWG. 70089 # 2

HOOD ASSEMBLY FRONT AND REAR VIEW

Part No. 70129 1 of 3

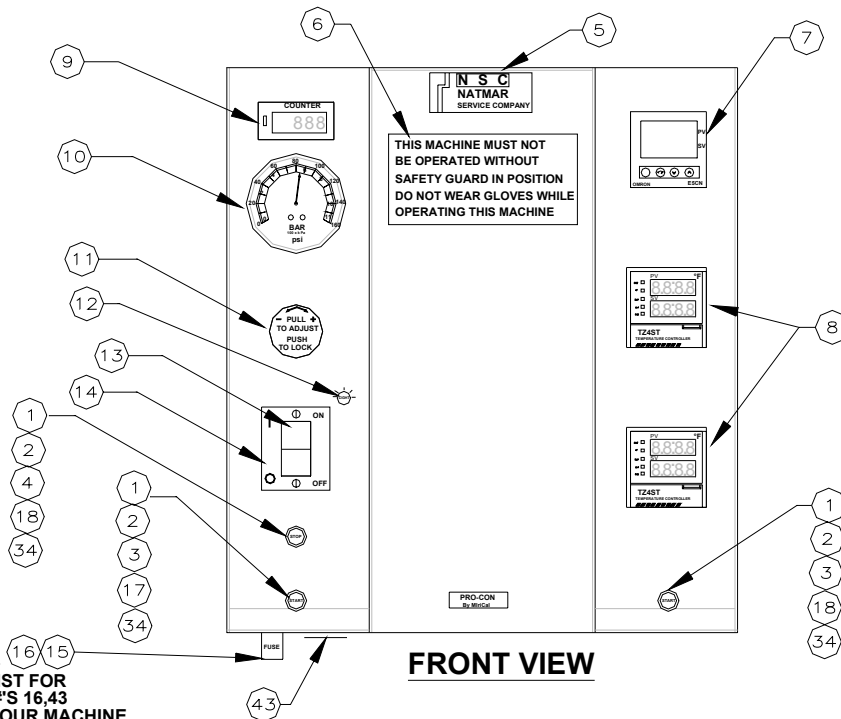
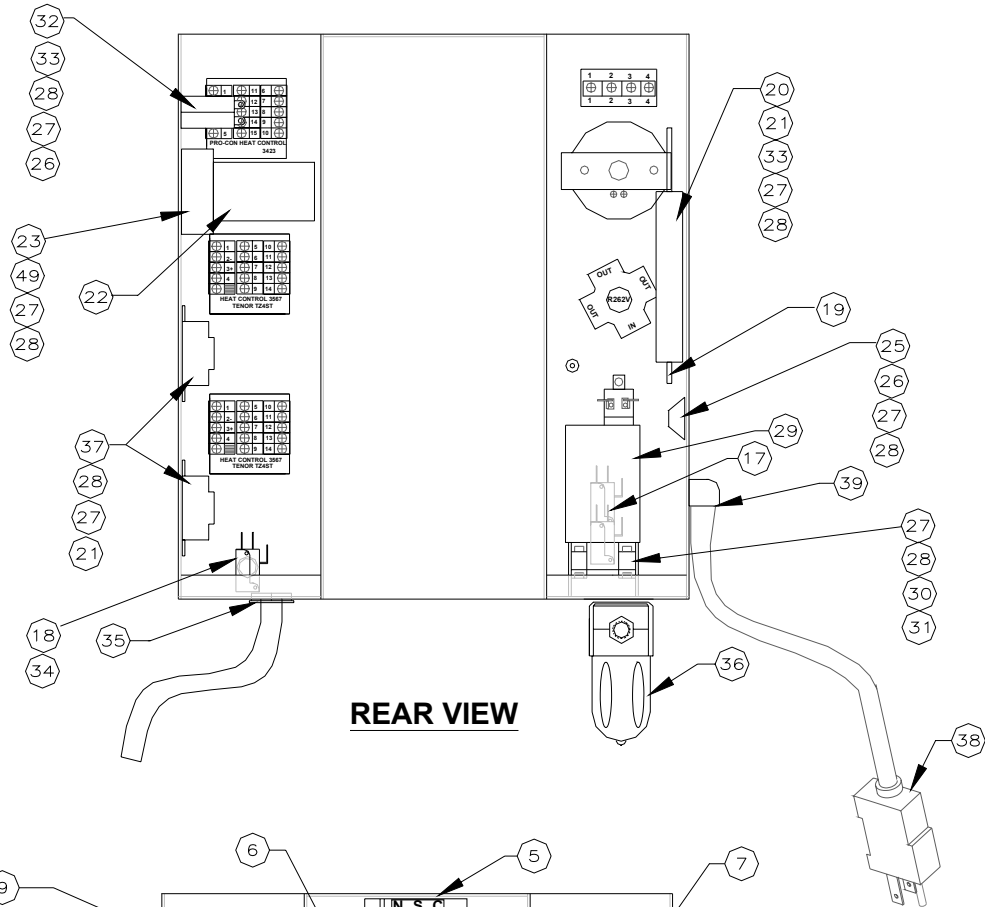

NOTE: 16, 15
SEE LIST FOR
ITEM #S 16, 43
FOR YOUR MACHINE
ON POWER INPUT
CIRCUIT DWG. #70079

HOOD ASSEMBLY
ISOMETRIC VIEW
Part No. 70129 2 of 3

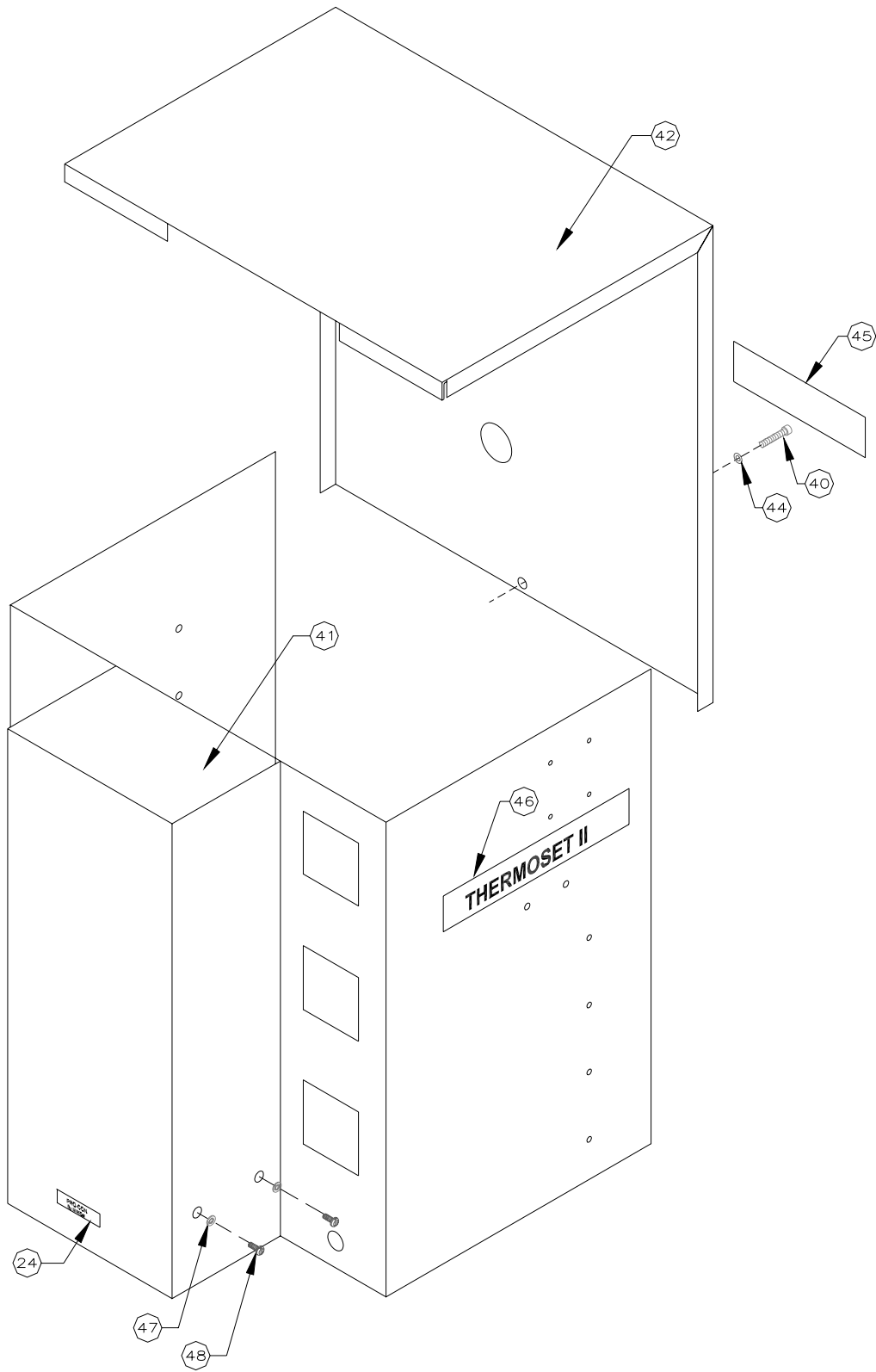

BILL OF MATERIAL
HOOD ASSEMBLY
Part No.70129 3 of 3

ITEM	DESCRIPTION	QTY.	PARTNUMBER
1	SHOROU-D-BUTTON START & STOP	3	2825
2	SCREW ADAPTER	3	3015
3	GREEN (START) BUTTON	2	2824
4	RED (STOP) BUTTON	1	2826
5	MATMAR LABEL	1	2873
6	WARNING LABEL	1	2856
7	PRO-CON HEAT CONTROL, OMRON	1	3423
8	HEAT CONTROL TENOR TZ4ST	2	3567
9	COUNTER-LA7N-2R	1	3303
10	AIR GAUGE REF.DWG. 322333 OR 32335 # 1	1	21983
11	AIR REG. W/MTG. NUT REF.DWG.32333 OR 32335 #12	1	20066
12	RED PILOT LIGHT # 679611	1	2044
13	ROCKER SWITCH	1	SEE DWG. 70079
14	ON / OFF PLATE	1	2225
15	FUSE HOLDER	1	SEE DWG. 70079
16	FUSE	1	SEE DWG. 70079
17	PUSH BUTTON SWITCH MOM 2 POLE	1	3305
18	SWITCH - PUSH BUTTON (START & STOP)	2	2823
19	TOUCH CONTROL BOARD	1	2025
20	MOUNTING 4" SNAPTRACK	1	2053
21	6/32 x 3/8 PAN HEAD SLOTTED MACH. SCREW	8	21058-05-F
22	TIMER	1	3426
23	SOCKET	1	3317
24	PRO-CON LABEL	1	70029
25	TERMINAL STRIP	1	1660
26	6-32 x 5/8 PAN HEAD SLOTTED MACH. SCREW	6	21058-08-E
27	# 6 INTERNAL LOCK WASHER	24	21021-05-A
28	6-32 HEX NUT	24	21051-06-A
29	ANTI TIE DOWN RELAY	1	3300
30	SOCKET - 8 PIN	1	3301
31	6-32 x 1 PAN HEAD SLOTTED MACHINE SCREW	2	21058-11-E
32	RELAY FOR COUNTER/TIMER	1	2864
33	# 6 FLAT WASHER	10	21023-22
34	NUT - (FOR SWITCHES)	3	70083
35	CABLE CLAMP	1	1624
36	AIR FILTER REF.DWG. 32333 OR 32335 # 16	1	20078
37	SOLID STATE RELAY	2	3568
38	POWER CORD	1	1695
39	STRAIN RELIEF BUSHING - NYLON	1	1630
40	SHCS 10-24 x 1/4	1	21063-02-I-N
41	FRONT COVER	1	30513
42	BACK COVER	1	26181
43	FUSE WARNING LABEL	1	SEE DWG. 70079
44	# 10 FLAT WASHER	1	21023-01
45	ELECTRIC CAUTION DECAL	1	3322
46	THERMOSET II DECAL	2	2896
47	1/4" INTERNAL LOCK WASHER	4	21021-09-A
48	1/4-20 x 3/8 LG. BUTTON HD. SCREW	4	21061-02-F
49	6-32 x 7/8" PAN HEAD SLOTTED SCREW	2	21058-10-E

FRAME ASSEMBLY 3" BORE CYLINDER 7" STROKE

Part No. 70089 1 of 2

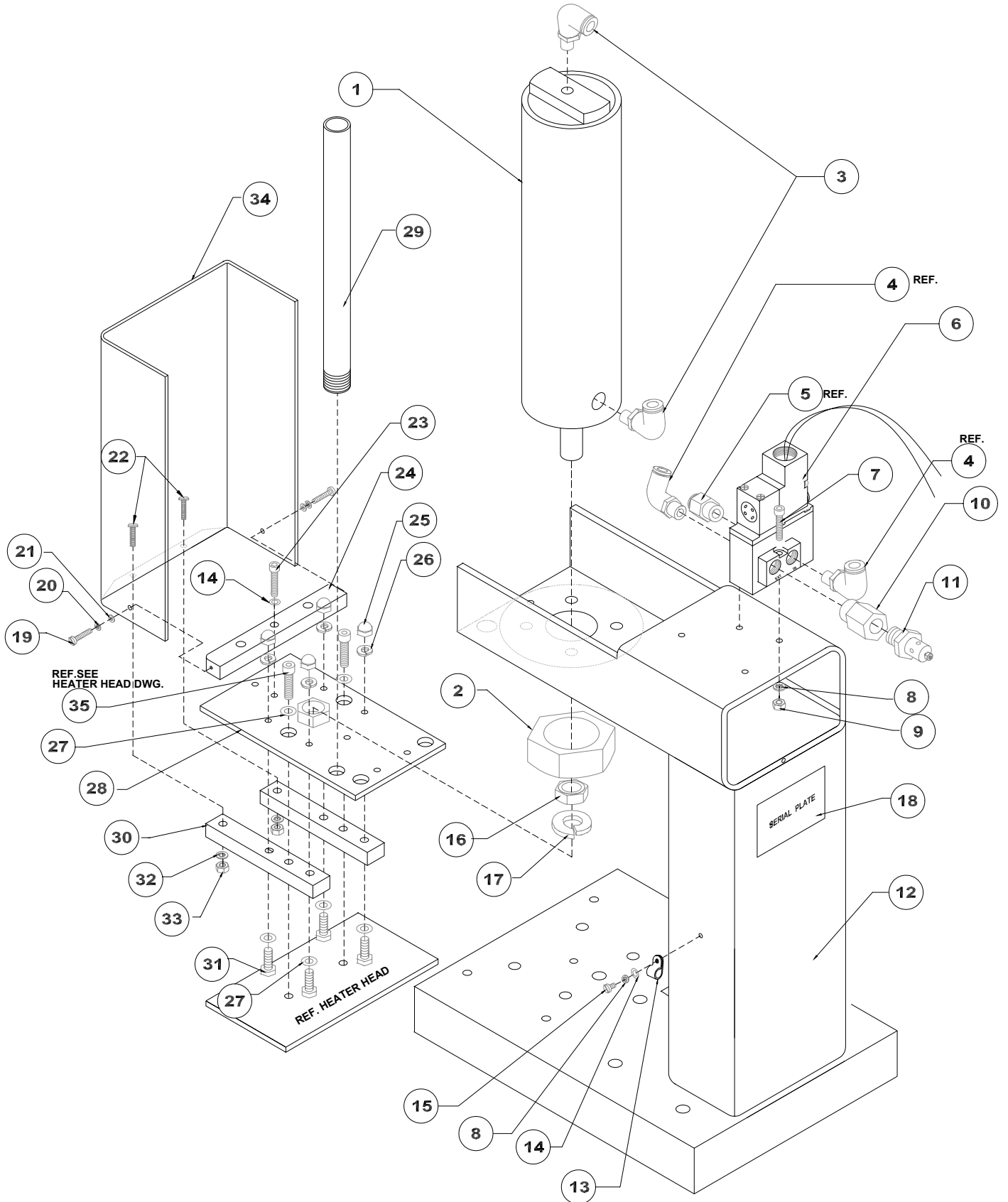

BILL OF MATERIAL
 FRAME ASSEMBLY 3" BORE CYLINDER 7" STROKE
 Part No. 70089 2 of 2

ITEM	DESCRIPTION	QTY.	PARTNUMBER
1	BIMBA AIR CYL. 3"BORE 7"STR.REF.DWG.32335 #10	1	3371
2	1 1/2-12 MOUNTING NUT REF.DWG.32335 # 19	1	3365
3	MALE ELBOW REF.DWG.32335 # 7	2	1938
4	ELBOW 3/8 TUBE x 1/4MPT (2) 22015-34	REF.	SEE DWG. 32335 # 9
5	CONNECTOR 3/8 TUBE x 1/4MPT (1) 20107	REF.	SEE DWG.32335 # 13
6	AIR VALVE REF.DWG.32335 #6	1	2324
7	# 10-32 x 1 1/4 SOC.HD. CAP SCREW	2	21063-09-J
8	# 10 INTERNAL LOCK WASHER	3	21021-07-A
9	# 10-32 HEX NUT	22	21051-09-A
10	BRASS ADAPTER 1/4FPT x 1/ MPT REF.DWG.32335#18	1	20113
11	SPEED CONTROL MUFFLER REF.DWG.32335 # 5	1	2339
12	FRAME WELDMENT	1	30439
13	3/8" PLASTIC WIRE CLAMP	1	D-1454
14	#10 PLAIN FLAT WASHER	2	21023-01
15	# 10-24 x 3/8 PAN HD. SCREW	1	21058-05-G
16	5/8-18 HEX NUT FOR BIMBA AIR CYL.	1	2373
17	5/8 SPLIT LOCK WASHER	1	21021-15-C
18	SERIAL PLATE	1	21977
19	# 6-32 x 1/2" PAN HD. SCREW	2	21058-07-E
20	# 6 INTERNAL LOCK WASHER	2	21021-05-A
21	# 6 FLAT WASHER	2	21023-22
22	#8-32 x 1" ROUND HD. SCREW	2	21057-11-F
23	# 10-32 x 1 SOCKET HD.SCREW	1	21063-08-J
24	SUPPORT SAFETY GUARD	1	22046
25	1/4-20 ACORN NUT	4	1200
26	1/4" SPLIT LOCK WASHER	4	21021-09-C
27	1/4" OMTERMA; ;PCL WASJER	6	21021-09-A
28	UPPER HD. MOUNTING PLATE (3" BORE CYL.)	1	32549
29	GUIDE ROD	1	28231
30	HEAT INSULATOR-UPPER	2	32256
31	1/4-20 x 3/4 FL. SOCKET CAP SCREW	4	21063-06-K
32	# 8 INTERNAL LOCK WASHER	2	21021-06-A
33	# 8 HEX NUT	2	21051-07-A
34	PLASTIC GUARD	1	28315
35	1/4-20 SOCKET HD.CAP SCREW (2)	REF.	SEE HEATER HEAD DWG.

LOWER HEATER ASSEMBLY (3" x 4") (120V)

Part No. 70005 1 of 2

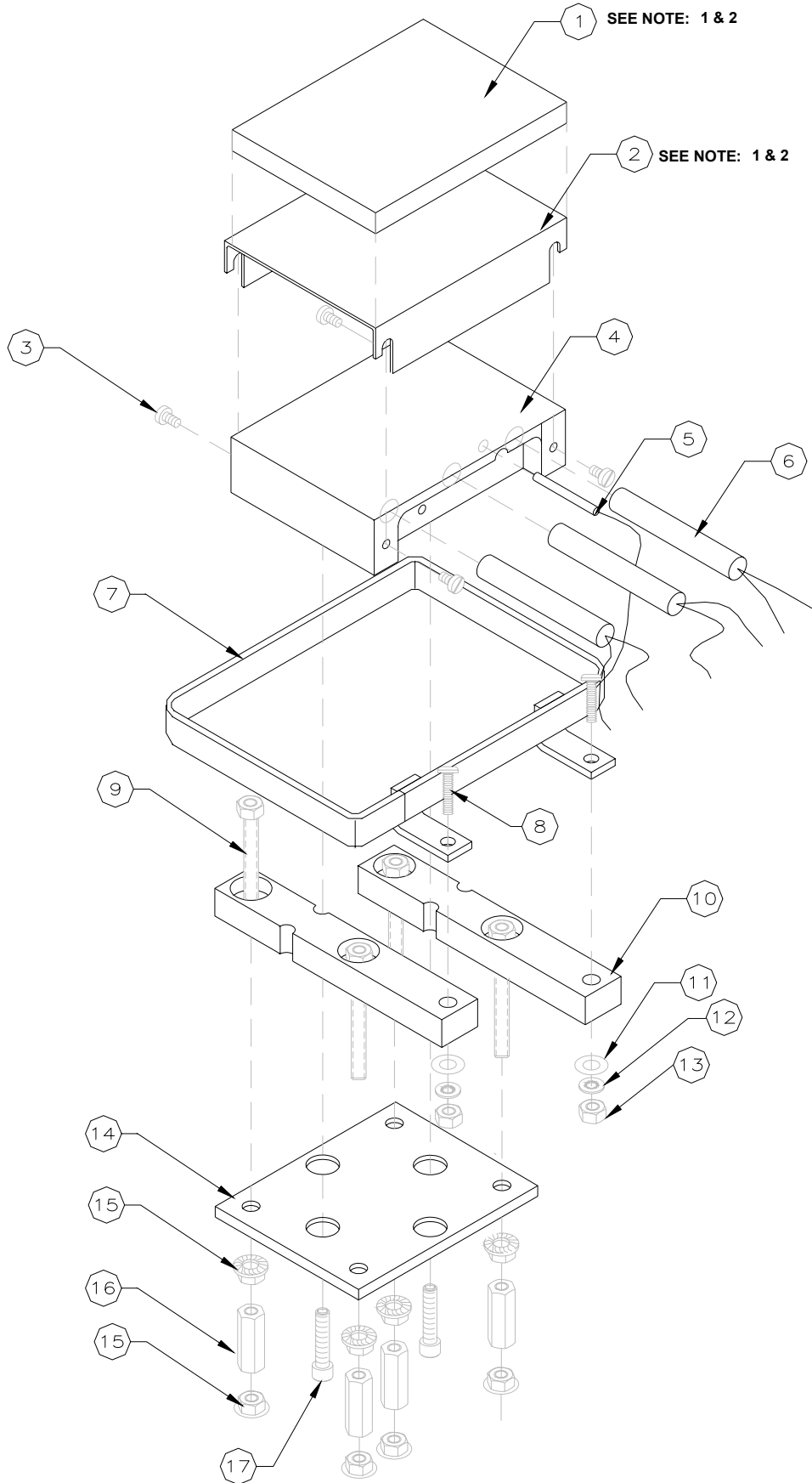

BILL OF MATERIAL
 LOWER HEATER ASSEMBLY (3" x 4")(120V)
 Part No. 70005 2 of 2

**NOTE:(1) PART # 36229, ASSY.PAD HOLDER
 INCLUDES PAD, 26119C AND HOLDER, 36384**

NOTE: (2)	ITEM #1 RUBBER PAD - PART #	THK.	MATERIAL
	26119A	.25	HARD RUBBER-PAD
	26119B	.50	HARD RUBBER- PAD
	26119C	.38	SPONGE RUBBER-PAD

ITEM	DESCRIPTION	QTY.	PARTNUMBER
1	(3x4) RUBBER PAD	1	SEE NOTE:2
2	(3x4) PAD HOLDER PLATE	1	36384
3	#10-24 x 3/8" PAN HEAD SCREW	4	21058-05-G
4	(3x4) HEATING HEAD	1	23713
5	THERMOCOUPLE TYPE J	1	2061
6	CARTRIDGE HEATER 3/8 D x 2 1/2 L (120V)	3	20375
7	(3x4) SAFETY BAR	1	32679
8	#8-32 x 7/8" PAN HEAD SCREW	2	21058-10-F
9	1/4-20 x 2 1/2 LG. HEX HEAD SCREW	4	1260
10	LOWER HEAD (3x4) INSULATOR BARS	2	32683
11	#8 PLAIN WASHER	2	21023-23
12	#8 INTERNAL LOCKWASHER	2	21021-06-A
13	#8 HEX NUT	2	21058-09-F
14	LOWER HEAD MOUTING PLATE	1	23673
15	1/4-20 WIZ NUT	8	1986
16	1/4-20 x 7/8 PL HEX NUT COUPLING	4	9770
17	1/4-20 x 7/8 SOCKET HD. CAP SCREW	2	21063-07-K

UPPER HEATER ASSEMBLY (3" x 4")(120V)

Part No. 70004 1 of 2

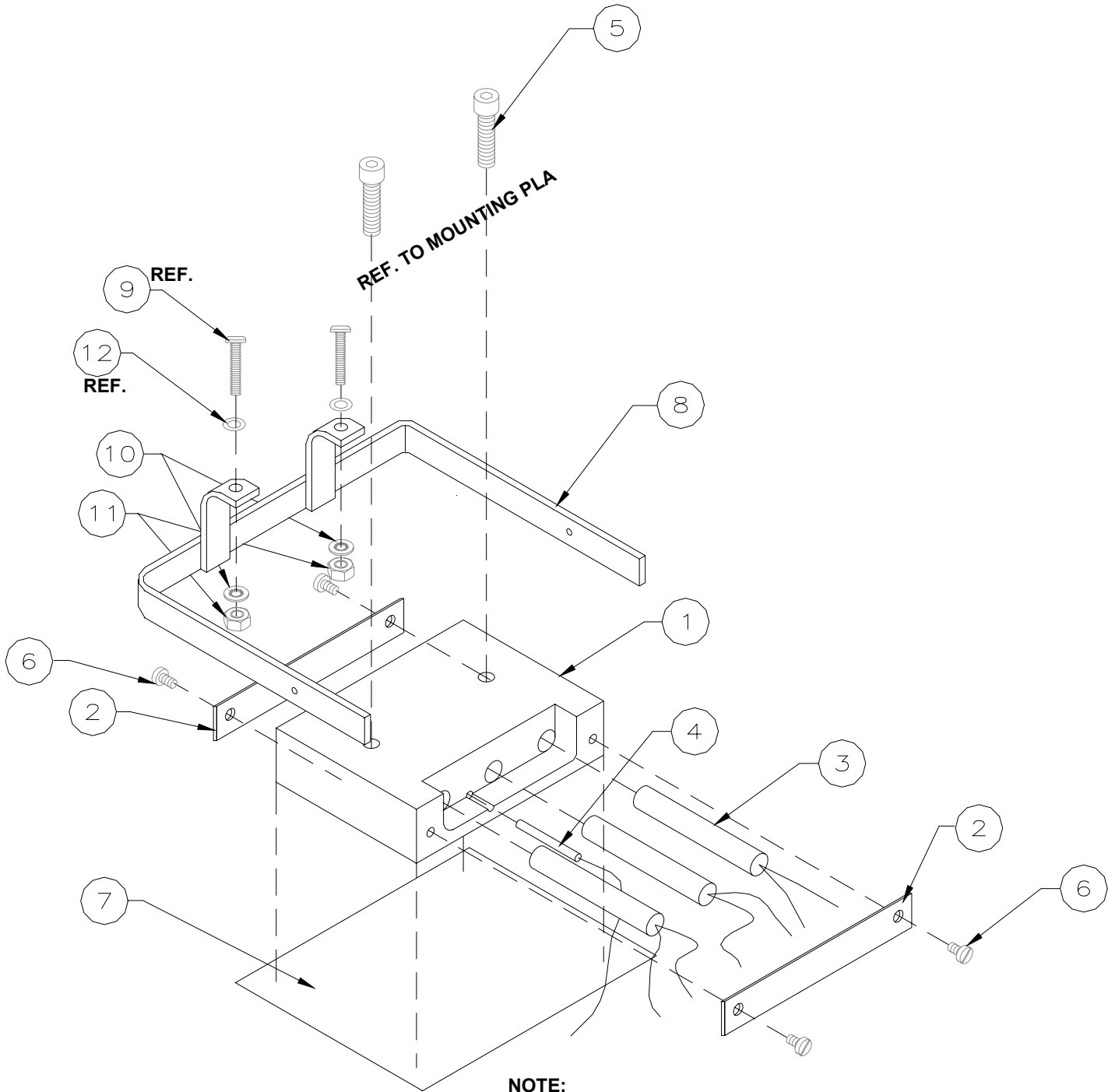

NOTE:
MACHINES WITH PRO-CON SEE
PART NO. 70114 FOR INSTALLATION
INSTRUCTIONS.

BILL OF MATERIAL
 UPPER HEATER ASSEMBLY (3" x 4")(120V)
 Part No. 70004 2 of 2

ITEM	DESCRIPTION	QTY.	PARTNUMBER
1	3" x 4" HEATER HEAD	1	23713
2	HEAD CLAMP	2	23714
3	HEATING ELEMENT (120 V)	3	20375
4	THERMOCOUPLE	1	2061
5	1/4-20 x 1" SOCKET CAP SCREW	2	21063-08-K
6	10-24 x 3/8" PAN HEAD MACH. SCREW	4	21058-05-G
7	TEFLON REPLACEMENT WITH PSA BACKING	1	70062-A
8	SAFETY BAR ASSY. (3"x4" HTR.)	1	30704
9	(2) SCREWS	REF.	SEE FRAME DWG.
10	(2) INTERNAL LOCK WASHER	REF.	SEE FRAME DWG.
11	HEX NUT (2)	REF.	SEE FRAME DWG.
12	(2) WASHER (SOME FRAMES DON'T HAVE THEM)	REF.	SEE FRAME DWG.

WIRING HARNESS 3" x 4" HEATER

Part No.70096

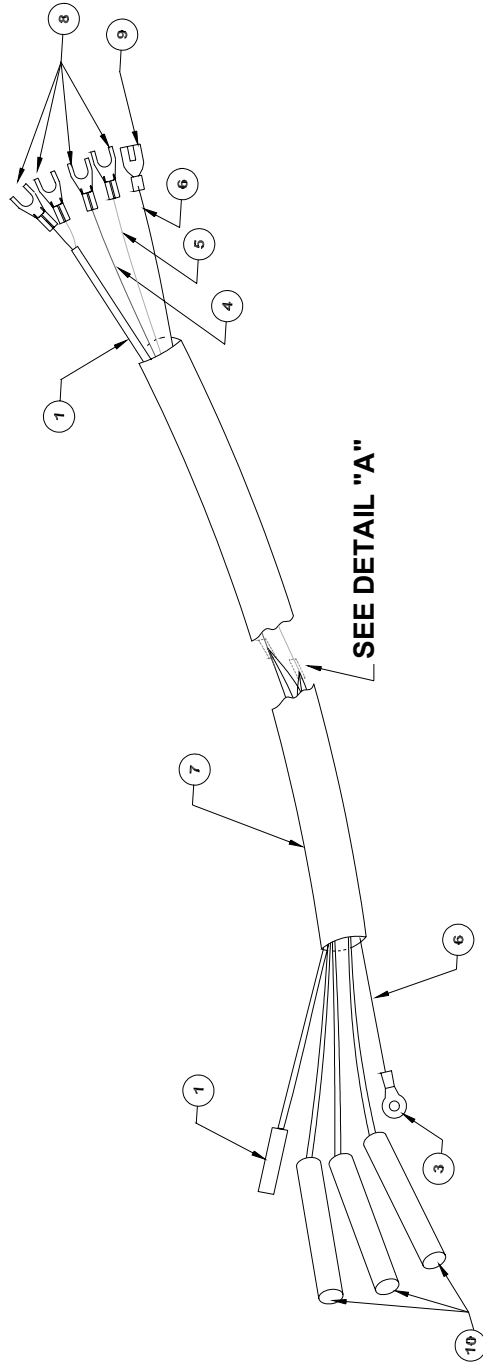

ITEM	DESCRIPTION	QTY.	PARTNUMBER
1	THERMOCOUPLE	1	2061
2	3/16" SHRINK TUBE	4 IN.	20080-16
3	RING CONNECTOR	1	2397
4	BLACK TEFLON WIRE	35 IN	9500
5	WHITE TEFLON WIRE	37 IN	9041
6	GREEN TEFLON WIRE	45 IN	2218
7	SLEEVING	2 FT.	20827
8	SHADE CONNECTPR 1/4"	2	2892
9	INSULATOR SLIP ON CONNECTOR 1/4"	3	20003-16
10	CARTRIDGE HEATER 3/8D x 2 1/2L W/10" WIRE	3	20375

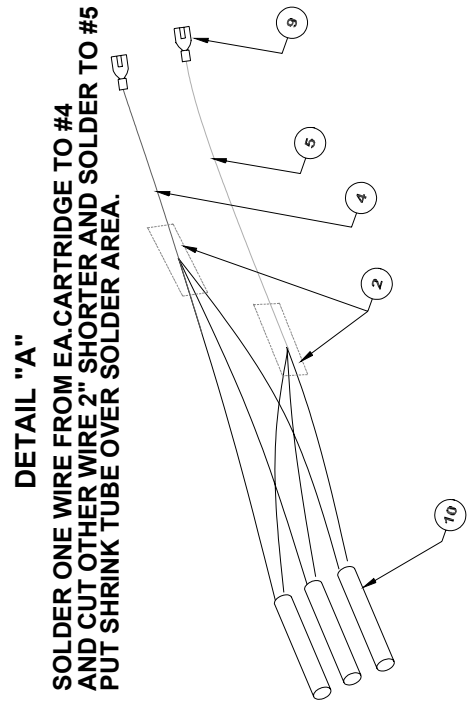

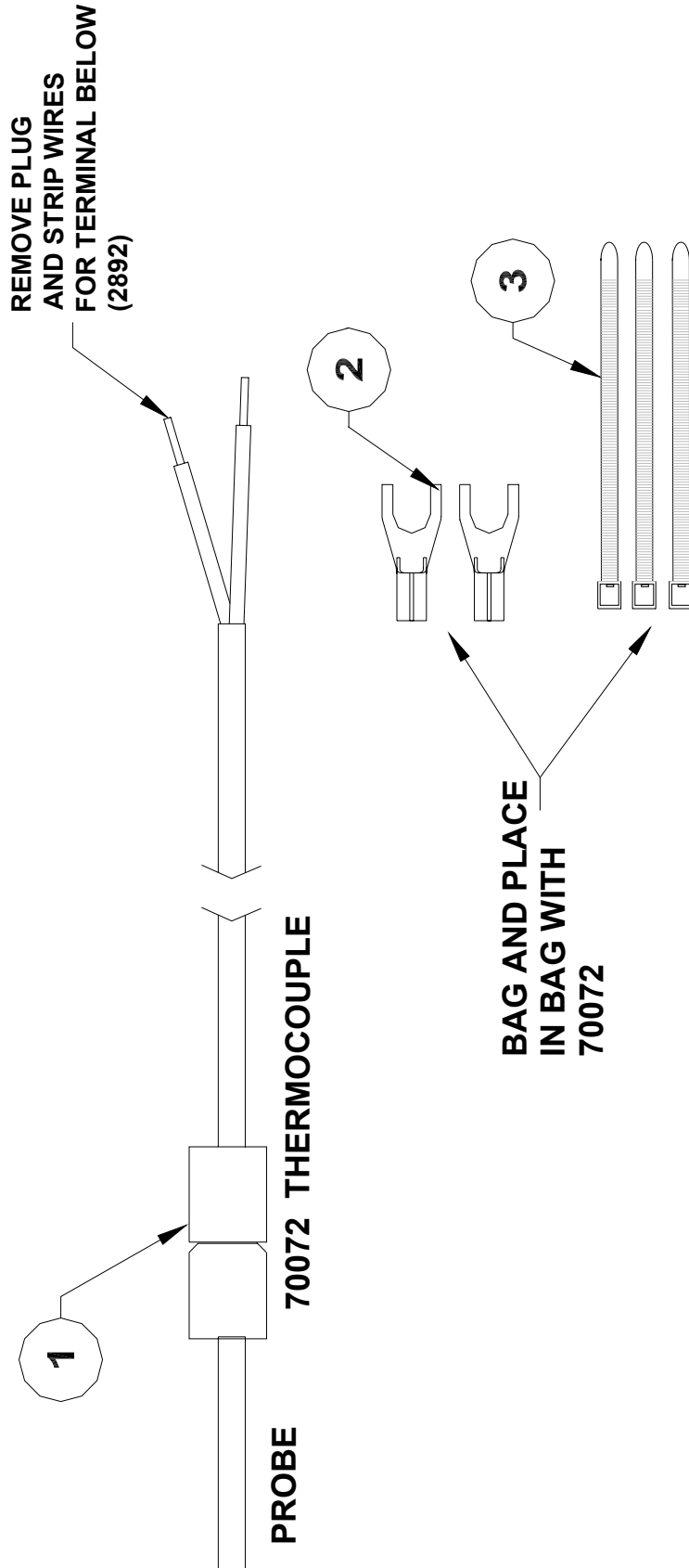

SURFACE PROBE W/PROCON ASSEMBLY
Part No. 70078





ITEM	DESCRIPTION	QTY.	PARTNUMBER
1	THERMOCOUPLE	1	70072
2	TERMINAL, SPADE #6	2	2892
3	CABLE TIES	3	D-3148



Pro-Con Setup Procedure



1. Press  and hold it until the display reads:  If the display reading is different,



press  or  until the display reads: 



2. Press  until the display reads:  The controller is set to Centigrade.



To change to Farenheit, press  or  until the display reads: 



3. Press  until the display reads: 



Press  or  until the display reads:  This sets the upper limit.



4. Press  until the display reads: 



Press  or  until the display reads:  This sets the lower limit.

5. Press  until the display reads: 



Press  or  until the display reads:  This sets the control mode.



6. Press  until the display reads: 



Press  or  until the display reads:  This sets the heating / cooling mode.



7. Press  until the display reads: 

Press  or  until the display reads:  This sets the operation mode.



8. Press  until the display reads: 



Press  or  until the display reads:  This sets alarm 1 type.



9. Press  until the display reads: 

Press  or  until the display reads:  This sets alarm 2 type.



10. Turn OFF the machine, wait 5 seconds and turn the machine back ON.

11. Press  and hold it until the display reads:  If the display reading is different,

press  or  until the display reads:  This sets the run / stop setting.

12. Press  until the display reads: 



Press  or  until the display reads:  This sets the upper alarm limit.

13. Press  until the display reads: 

Press  or  until the display reads:  This sets the lower alarm limit.



14. Turn OFF the machine, wait 5 seconds and turn the machine back on.
This completes the setup.

Pro-Con Lockout Procedure

1. Press  and  and hold them until the display reads: 

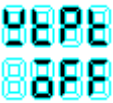
Press  until the display reads:  This locks the set point from being changed by the operator

2. Press  until the display reads: 

Press  until the display reads:  This locks the internal settings from being changed by the operator.

3. Turn off the machine, wait 5 seconds and turn the machine back on. This completes the lockout procedure.

PRO-CON CONTROLLER

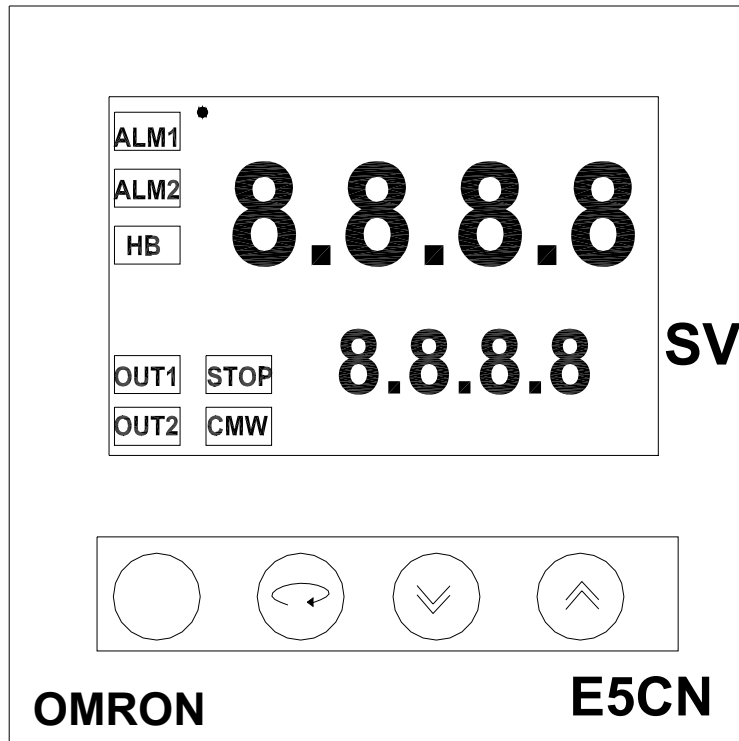

PV (Process Value = Surface Temperature) –Surface temperature Should be set at approximately 400° Set upper heat controller to Temperature needed to achieve 400° Typically, this would be 415° to 420°. Actual surface temperature will fluctuate several degrees above and below 400°.

SV (Set Value) – Set value should be Set at the optimum temperature to Melt the label adhesive. Normally This would be between 370° to 380° Test label to determine the optimum Temperature.

Heat controllers – Dual digital heat Controllers for each platen are Located below the Pro-Con Controller. The temperatures are Factory set at 415° - top and 200° - Bottom. Increasing bottom platen Temperature may help to reduce Average dwell time.

PRO-CON INSTALLATION INSTRUCTIONS (3 x 4 HEATER HEAD)

Part No. 70114

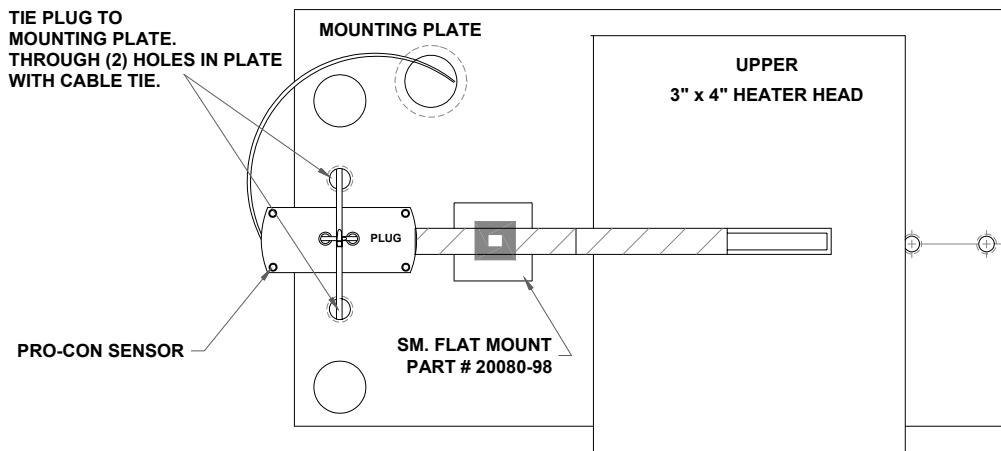
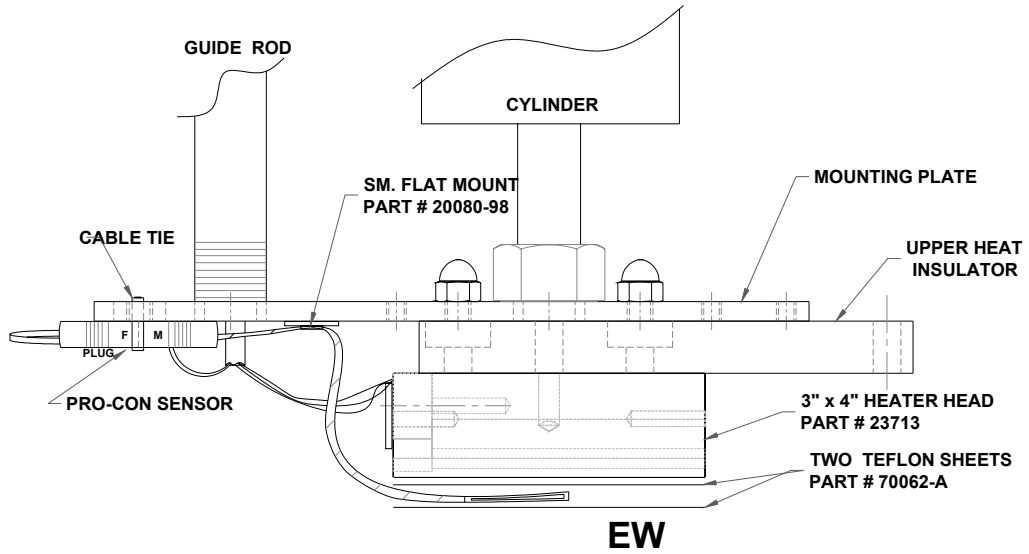

BOTTOM VIEW

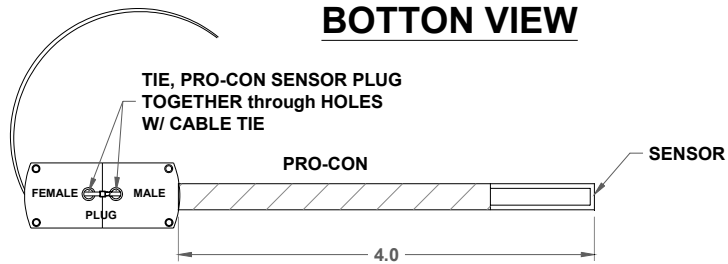

Surface Probe Attachment

