

**NSC
HEAT SEAL MANUAL**

Thermoset III

MODEL NUMBER HS171-1, HS172-1



Natmar Services Company

139 Beattie Street • P.O.Box 6743 • Syracuse, NY 13217

Toll Free 800-798-8206 • Local (315) 445-2419 • Fax (315) 445-8046

Visit us on the web at www.natmar-nsc.com

Table of Contents

	Page
Warranty	3
Unpacking & Installation.....	4
• Checking Shipment/Warnings & Cautions/Installation/Air Supply/Electrical Requirements	
Operation	6
Heat Sealing	8
• Heat Sealing Guide	
Periodic Maintenance	9
Troubleshooting-General	11
Troubleshooting-Heat Related Problems & Air Leaks	12
Digital Temperature Control	13
Re-setting the Heat Controller	14
Touch Board Adjustment	17
Low Air Pressure Switch	18
Delay Timer Safety Feature-Overview	19
Foot Switch Assembly-Overview/Warning	20
<u>Schematic Drawings</u>	
Foot Switch w/Guard	21
Machine-General (M-1)	22
Frame Assembly (M-2)	23
Upper Head Mounting (M-3)	24
Upper Head Assembly (M-4)	25
Lower Head Assembly (M-5)	26
Front Cover Assembly (M-6)	27
Start Switch Assembly (M-9)	28
Air Cylinder Assembly (P-1)	29
Solenoid Valve Assembly (P-2)	30
Air Regulator & Pressure Switch Assembly (P-3)	31
Air Filter/Air Gauge Assembly (P-4)	32
Pneumatic Diagram (P-5)	33
Wiring Diagram-120 Volt (E-1)	34
Wiring Diagram-240 Volt (E-2)	35
70145 Heat Controller Set Up Instructions	36
70184 Timer, Replacement Set-up Instructions.....	40



Innovators of the Future

Natmar Services Company

139 Beattie Street • P.O. Box 6743 • Syracuse, NY 13217

Toll Free 800-798-8206 • Local (315) 445-2419 • Fax (315) 445-8046

Warranty For Heat Seal Machine

Natmar Services Company, Syracuse, New York ("Seller") warrants this Heat Seal machine to be free from defects in material and workmanship under normal use and service. Any part which proves to be defective in material or workmanship within one year of the date of original purchase for use, will be repaired or replaced, at Seller's option, free of service or labor charges, with a new or functionally operative part. Seller's liability under the Warranty shall be limited to repairing or replacing at its own factory or through an authorized service distributor or dealer, material which is determined by Seller to have been defective in manufacture and upon which a claim has been made by the original purchaser or user to Seller (or an authorized distributor or dealer) within the warranty period. An authorized officer of Seller will honor claims under this Warranty only upon written approval. Approved return of parts or products will be on a prepaid transportation charges basis only. Claims under this Warranty will be honored only upon Seller's determination that the claim is covered by this Warranty, and Seller shall incur no obligation under this Warranty prior to such determination. This Warranty does not apply: (1) To any machinery or equipment which has been altered or repaired, except by Seller or its authorized representatives, or (2) to any machinery or equipment which has been subject to misuse, negligence, or accident, including, without limitation, use an operation of such machinery or equipment while parts are loose, broken, out of order, or damaged by the elements. Parts replaced under this Warranty are warranted only through the remainder of the original Warranty. Any and all claims for warranty service must include such information as Seller designates, and shall include specifically the serial number of each unit (if appropriate).

The foregoing shall constitute the sole and exclusive remedy of any using purchaser and the sole an exclusive liability of Seller in connection with this product. THIS WARRANTY IS IN LIEU OF ALL OTHER WARRANTIES, EXPRESS, IMPLIED OR STATUTORY, INCLUDING BUT NOT LIMITED TO, ANY WARRANTY OF MERCHANTABILITY OR FITNESS AND ALL OTHER OBLIGATIONS OR LIABILITIES OF SELLER, INCLUDING ANY TORT LIABILITY, FOR NEGLIGENT DESIGN OR MANUFACTURE OF THIS PRODUCT, OR OTHERWISE. It is expressly agreed that Buyer shall not be entitled to recover any incidental or consequential damages, as those terms are defined in the Uniform Commercial Code, and that Buyer shall have no right of rejection or of revocation of acceptance of any part or of revocation of acceptance if any part or all of the goods covered hereby.

Natmar Services Company reserves the right to make changes in design and changes or improvements upon its product without imposing any obligation upon itself to install the same upon its products previously manufactured.

1. UNPACKING AND INSTALLATION

1-1 CHECKING SHIPMENT

- A. The machine is shipped fully assembled
- B. Check items received against item on the packing slip. Thoroughly check the machine for any damage that may have occurred in transit. Advise the carrier of any damage or missing components within seven (7) days.

1-2 NOTES, CAUTIONS AND WARNINGS

Notes, cautions and warnings are used throughout the manual to emphasize important and critical instructions.

NOTE: A note is used to emphasize operation procedures, practices, etc...essential for proper use.

CAUTION: A caution is used to emphasize operating procedures, practices, etc., which if not strictly observed may result in damage to the machine.

WARNING: A warning is used to emphasize operation procedures, practices, etc., which if not strictly followed may result in person injury or loss of life.

1-3 INSTALLATION

The machine may be installed on any level surface capable of supporting its weight. It should be located at least 12 inches from the closest object for ease of maintenance, and should be set back at least 6 inches from the edge of the bench or table on which it rests. Consistent with these requirements, the machine may be further arranged for maximum operator comfort and efficiency.

1-4 AIR SUPPLY

Connect air to the air filter, located at the rear of the machine. Set machine at a minimum of 60-PSI incoming pressure.

CAUTION: Use clean dry air only. The machine air filter will remove normal amounts of condensation and foreign matter only. If the air service contains an excessive amount of condensation and foreign matter, a trap, filter and/or dehydrator should be installed in the air service line, upstream from the machine.

1-5 ELECTRICAL REQUIREMENTS

The current is supplied to the machine through the power cord, which may be plugged into any power source that has 110-120 VAC 60HZ receptacles. These machines have the following requirements:

	<u>Requirement (Amps)</u>	<u>Fuse Size (Amps)</u>
Thermoset III 4" X 6" Platens	9	10
Thermoset III 3" X 4" Platens	5.5	7
Easy Seal	13	15

NOTE: There is an option for a 240 VAC 50 HZ source machine which utilizes a breaker instead of a fuse.

WARNING: ELECTRICAL GROUNDING INSTRUCTIONS

The power supply cord has a 3-prong grounding for your personal safety. It must be plugged into a mating 3-prong grounding type wall receptacle, grounded in accordance with the National Electrical Code and local codes and ordinances.

DO NOT REMOVE THE GROUND PLUG

DO NOT USE AN EXTENSION CORD

2. OPERATION

Before starting the machine, it is important that the operating personnel become thoroughly familiar with the operating instructions. The major assemblies of the machine are the upper and lower heating heads. The upper head is lowered and raised by an air cylinder and the lower head remains stationary.

- 2-1 PRO-CON CONTROLLER
This machine is equipped with a feature called Pro-Con located in the upper right corner of the cabinet face. The Pro-Con uses temperature rather than time to determine the end of the sealing cycle. For further information, see the Pro-Con section in the manual (Pgs. 14, 27-28, 37-46)
- 2-2 AIR REGULATOR
Pull knob out 1/8". Turn knob clockwise to increase; counter-clockwise to decrease air pressure to machine. Machine will operate normally at 80 lbs. pressure. Push knob in after adjusting.
- 2-3 AIR PRESSURE GAUGE
The air pressure gauge indicates the air pressure used to force the upper platen to descend. The adjustable air pressure regulator positioned just below the gauge controls the reading on the gauge and the pressure applied to the heating heads. Turning the regulator clockwise increases the pressure up to the line pressure that is supplied to the machine. SET THE AIR GAUGE ACCORDING TO THE LABEL MANUFACTURE'S SPECIFICATIONS.
- 2-4 TIMER
A timer set at six seconds is located in the machine cabinet. This is the minimum amount of time that the upper platen will be in the down position. After the timer reaches six seconds and the SV matches or surpasses the PV on the digital display of the Pro-Con controller, the upper platen will return to its original up position ready for the next application.
- 2-5 POWER ON/OFF SWITCH
Controls all electric power to the machine. The switch setting can be determined from the position on the rocker. A signal light to the lower right of the power switch indicates the presence of electric power.
- 2-6 EMERGENCY RELEASE BUTTON
Pressing the large red button will stop the machine cycle and return the top-heating head to its upper position.
- 2-7 COUNTER
This counter counts only if the head goes down and the set time has elapsed in its entirety. Pressing the button located on the left side of the counter may reset the counter.
- 2-8 DUAL GREEN START BUTTONS
This machine is equipped with an anti-tie down relay and time delay switch. To operate the machine, both green start buttons must be pressed simultaneously and held until the upper platen makes contact with the bottom platen.

- 2-9 EMERGENCY RELEASE BAR
Emergency release bar surrounds the upper head. Contacting the bar with the operator's skin, hand or otherwise, will cause the platen to release.
- 2-10 DIGITAL TEMPERATURE CONTROL
There are two controllers located on the right side of the cabinet under the timer. Temperatures are preset at the factory. **DO NOT CHANGE TEMPERATURES WITHOUT FIRST CONTACTING THE FACTORY.**
- 2-11 FOOT PEDAL
This machine is wired to accept a foot pedal as an option to operate the machine. To operate the machine using the foot pedal, the operator must insert a foot under the safety guard and depress the foot pedal switch. The switch must remain depressed until the upper platen makes contact with the bottom plate. Once this occurs, the foot may be removed.
- 2-12 MACHINE SHUTDOWN FEATURE – AIR PRESSURE AND TEMPERATURE
This feature is designed to insure the machine is being operated at the proper sealing conditions. The machine will cease to operate under the following conditions:
- A. Air pressure drops below 20 #.
 - B. Temperature of either heat controller deviates 15° from the set point.
 - C. Temperature deviates +/- 20° from the 380° factory set Pro-Con Set Value (SV-green display).

3. HEAT SEALING

3-1 GENERAL

The machine uses heat and pressure to apply or remove heat sensitive labels. The Pro-Con feature ensures that the label is exposed to the optimum heat sealing conditions regardless of variables such as: fabric weight and/or type, humidity, residual heat acquired while machine in operation, or loss due to inactivity. Temperature and air pressure are factory set based on knowledge of flow points of adhesives used with typical garment labels. This should enable the machines to be used with most known labels. The Pro-Con Set Value may be changed slightly to better accommodate some labels. Additional changes in air pressure may be necessary in order to accommodate some labels; in these cases, refer to label manufactures pressure specifications.

3-2 OPERATING INSTRUCTIONS

Sequence of actions:

- A. Place the article on top of the bottom heating head. Place the label or patch adhesive side down on top of article. Arrange the work in the exact position in which it is to be bonded, center on the head. Apply tension to the article to avoid wrinkles being set in by heat.
- B. Remove hand and fingers from the heating head area.
- C. Depress the start buttons simultaneously or depress the foot switch and hold until upper platen contacts the lower platen (Pg. 18).
- D. After the upper platen returns to the start position. Remove article.
- E. To separate bonded material, pull apart the articles using tweezers. The materials are too hot for bare hands.

4. PERIODIC MAINTENANCE

Machine malfunctions and damage to articles being processed can be minimized by performing the periodic inspections below. These inspections should be made daily.

4-1 INSPECTION PROCEDURE

- A. Check temperature, pressure and time settings and reset if they have been changed.
- B. Check external airline filters and traps. Clean out as required.

Periodically, the filter element and bowl should be removed and cleaned. To remove the filter element, the filter must be depressurized and the bowl removed. The bowl should be washed with soapy water.

WARNING: Never disassemble unit under pressure. Relieve all pressure before disassembling.

The filter element can be washed in the same solution as the bowl. After washing, dry air filter element by blowing compressed air from inside outwards. Replace and reassemble bowl.

CAUTION: Never wash transparent bowls with gasoline or any fluids containing acetone, ethyle acetate, ethylene, dichloride, toluene, etc...which will damage bowl.

- C. Inspect Teflon head covers for damage or wear. Replace as necessary. Wiping off any sticking adhesive periodically will help to extend the life of the Teflon covers.
- D. Check safety bar for damage and for proper operation.
- E. Clean the machine.

The machine should be thoroughly dusted at the end of each day's operation.

NOTE: Occasionally, adhesive, lint, etc., may build up on the underside of the heating head and platen cover. This build up can be removed by starting the machine and wiping the build up off with a cloth after heating heads are warm.

WARNING: Always disconnect the power plug from the outlet and the air line before performing repairs.

THE USE OF SYNTHETIC OILS IN THIS MACHINE WILL HAVE A NEGATIVE EFFECT ON THE "O" RINGS IN THE AIR VALVE CAUSING THE MACHINE TO BECOME INOPERABLE.

WE RECOMMEND THAT **NO** OIL BE PLACED INTO THE AIR SYSTEM OF THIS MACHINE.

5. TROUBLE SHOOTING
STANDARD MODELS ONLY

<u>Trouble</u>	<u>Possible Cause</u>	<u>Corrective Action</u>
Head will not descend	<ul style="list-style-type: none"> • Defective start/stop switch • Timer defective • Top head not in position • Defective anti-tie-down relay • Defective air valve • Defective touch control board 	<ul style="list-style-type: none"> • Replace switch or adjust start switch • Replace timer or relay • Move head to full right or left position • Check for faulty regulator • Replace valve • Replace cylinder • Reduce touch sensitivity-bypass touch board, call Natmar for instructions
Head will not rise	<ul style="list-style-type: none"> • Defective timer or relay • Defective valve 	<ul style="list-style-type: none"> • Replace timer or relay • Replace valve
Head descends or rises too slowly	<ul style="list-style-type: none"> • Improper air pressure 	<ul style="list-style-type: none"> • Check and adjust air regulator
Head will not remain down	<ul style="list-style-type: none"> • Defective timer • Improper timer setting • Damp clothes • Sensitivity on touch board too high 	<ul style="list-style-type: none"> • Replace timer or relay • Adjust timer • Reduce sensitivity by turning knob counterclockwise
No heat or too much heat at one heating head	<ul style="list-style-type: none"> • Defective thermocouple-Easy Seal • Defective temp controller-Easy Seal • Defective heating head • Loose or broken wire connection • Defective head control relay 	<ul style="list-style-type: none"> • Replace thermocouple • Replace temperature controller • Replace heating head • Restore wire connections • Replace relay
Weak bond	<ul style="list-style-type: none"> • Timer set incorrectly for operation being performed • Temperature too high or too low • Incorrect air pressure • Defective tapes 	<ul style="list-style-type: none"> • Adjust timer • Adjust temperature of heads • Adjust air regulator • Call manufacturer of tapes to obtain suggested sealing conditions
Audible air leak or “blow-by” in valve	<ul style="list-style-type: none"> • Defective valve • Sticking valve • Cylinder “O” ring or piston cup worn 	<ul style="list-style-type: none"> • Replace valve • Replace valve • Repair or replace air cylinder

Troubleshooting Heat Related Problems & Air Leaks

Head will not descend:

- Check air gauge and air pressure
- Check if timer is operating. If the timer is operating properly, then check the timer with a voltage meter to see if you are getting power out of the timer and to the air valve.
IF YES, then the air valve (part # 2324 or # 2959 on 100 volt machines) is defective.
IF NO, then the timer (part # 2860) is defective.
- Check the touch board (part # 2025). The green light should be "**ON**" and the red light should be "**OFF**" for proper operation. See page titled "installation and use of model 2025 touch board". If the machine then operates, the board could be defective.
- Check the anti-tie down relay (ATD Relay). The blue plug in device that is located behind the ON/OFF switch. Swap relays to see if problem follows with the relay, if so, replace the anti-tie down (ATD Relay-part # 3300)
- Next, check for voltage on the timing circuit by placing one probe on the terminal strip (part # 1660) where the white wires connect. Carefully place the other probe one at a time on the following:

NC	on the touch control board (part # 2025)
C	on the red stop switch (part # 2823)
RED	wires on the terminal strip (part # 1660)
C	on the single start switch (part #2823)
C	on the double start switch (part # 3305) *

*There are two poles; power should be on one pole at time, alternating when the single start button is pushed.

Unplug the ATD Relay (part # 3300). There should be power on #3. Press both green buttons and there should be power on #2 & #8 (may be helpful to have another person assist in pressing buttons.) Plug the ATD Relay back in and check for power at #7 on the timer (part # 2860)

- By now the defective part should have been located. If not, call Natmar Services Company @ 1-800-798-8206 for assistance.

Head will not rise:

- Turn the machine off by moving the ON/OFF rocker switch (part # 2150) to the **OFF** position. If the head remains down, then the Air valve (part # 2324) is defective.
- Check the timer for proper setting. Make sure the last digit is on the **S** for seconds.

Head will not remain down:

- Check the timer for proper setting. Make sure the last digit is on S for seconds.
- Make sure garments are dry. Wet garments will trigger the safety bar feature, preventing the head from staying down.
- See page titled "installation and use of model 2025 touch control board" for proper setup and operation of the touch control board. You may have to reset the sensitivity. Actuator collar must make contact with the switch # 20055-62. Actuator collar is located at the top of the guide rod. Guide rod screws into the upper head mounting plate. Tighten guide rod by turning clockwise. Adjust switch to ensure that actuator collar is making contact with switch.

No heat on one head:

- Check to see if heat controller is set at the proper setting. Check **SV** setting on the controller (green number)
- Check to see if heat controller is calling for heat. Out light should be showing **ON**. If heat controller is not **ON** the thermocouple could be bad. Replace thermocouple (part # 2061)
- Switch heat controllers between the two heads. If the problem follows the controller, the controller should be replaced
- Check the voltage between the white wire on the terminal strip and #2 on the solid-state relay (part # 3568). If there is no voltage, replace the relay.
- Remove cover on rear of head and check for voltage between white and black wire. If there is voltage, the head is bad. Replace heating head (part # 23180). If there is no voltage, check for broken wires leading to the heating head.

AUDIBLE AIR LEAK

For air leaking around the shaft of the cylinder:

- Repair Air Cylinder with repair kit #2612A

Audible Air leak out of muffler on air valve

- Air leaks when head is up:
Remove airline from top of air cylinder and check if air is coming out of cylinder. If yes, replace cylinder internal seals (part # 2612B).
- If no, replace air valve (part # 2324)

Air leaks when head is down:



- Unplug machine and shut off air supply to the machine. Remove the airline between air valve and bottom of cylinder (at the air valve #2324). Turn air back on (air will come out of the airline) and press the small white button on the right side of the air valve. Check for air coming out of the airline while the button is in. If yes, replace the cylinder's internal seals (repair kit #2612B)
- If no, replace air valve # 2324

Digital Dual Display Heat Controllers

To change the temperature:

Process Value (PV- red display) – actual temperature





















Set Value (SV – green display) – temperature setting















Press . The display will read: $\begin{matrix} 400 \\ 5P \end{matrix}$. Press the  or  arrow

buttons to change the setting. Press  to save the change.

To reset the ORIGINAL heat controller P/N: 70145









*When replacing original controller, use set up procedure on page 45



1. Press . The display should read: $\begin{matrix} 80 \\ 5P \end{matrix}$. If it doesn't, Press the  or  arrow buttons until the display reads: $\begin{matrix} 80 \\ 5P \end{matrix}$ and press .
2. **Turn the machine OFF and allow it to cool down to room temperature.**
3. Turn the machine ON.
4. Press , hold it and press . The display will read: $\begin{matrix} 0P\epsilon r \\ 5L\epsilon\epsilon \end{matrix}$.
5. Press  until the display reads: $\begin{matrix} CONF \\ 5L\epsilon\epsilon \end{matrix}$.
6. Press . The display will read: $\begin{matrix} 0 \\ 0L\epsilon\epsilon \end{matrix}$. Press the  or  arrow buttons until the display reads: $\begin{matrix} 20 \\ 0L\epsilon\epsilon \end{matrix}$.
7. Press . The display should read: $\begin{matrix} JF \\ 0P\epsilon \end{matrix}$. If it doesn't, Press the  arrow button until the display reads: $\begin{matrix} JF \\ 0P\epsilon \end{matrix}$. (The JF will flash)
8. Press . The JF will stop flashing.
9. Press  until the display reads: $\begin{matrix} bR\epsilon d \\ R\epsilon R\epsilon \end{matrix}$. If it doesn't, Press the  or  arrow buttons until the display reads: $\begin{matrix} bR\epsilon d \\ R\epsilon R\epsilon \end{matrix}$. (**The BAND will flash**)
10. Press . The BAND will stop flashing.
11. Press  until the display reads : $\begin{matrix} 15 \\ bR\epsilon\epsilon \end{matrix}$. If it doesn't, Press the  or  arrow buttons until the display reads: $\begin{matrix} 15 \\ bR\epsilon\epsilon \end{matrix}$. (**The 15 will flash**)



12. Press . The 15 will stop flashing.
13. Press  until the display reads: $\begin{matrix} \text{RLR1} \\ \text{inh1} \end{matrix}$. If it doesn't, Press the  or  arrow buttons until the display reads: $\begin{matrix} \text{RLR1} \\ \text{inh1} \end{matrix}$. (**The ALA1 will flash**)
14. Press . The ALA1 will stop flashing.
15. Press  until the display reads: $\begin{matrix} \text{PRI} \\ \text{USE1} \end{matrix}$. If it doesn't, Press the  or  arrow buttons until the display reads: $\begin{matrix} \text{PRI} \\ \text{USE1} \end{matrix}$. (**The PRI will flash**)
16. Press . The PRI will stop flashing.
17. Press  until the display reads: $\begin{matrix} \text{A2_r} \\ \text{USE2} \end{matrix}$. If it doesn't, Press the  or  arrow buttons until the display reads: $\begin{matrix} \text{A2_r} \\ \text{USE2} \end{matrix}$. (**The A2_r will flash**)
18. Press . The A2_r will stop flashing.
19. Press  until the display reads: $\begin{matrix} \text{UF} \\ \text{inPt} \end{matrix}$.



Turn OFF the machine, WAIT 5 seconds and turn the machine ON.



The **lower** display will read: $\begin{matrix} \text{80} \end{matrix}$.

20. Press , hold it and press  The display will read: $\begin{matrix} \text{OPER} \\ \text{SLCT} \end{matrix}$.
21. Press  until the display reads: $\begin{matrix} \text{SETP} \\ \text{SLCT} \end{matrix}$.
22. Press . The display will read: $\begin{matrix} \text{0} \\ \text{ULOC} \end{matrix}$.
23. Press the  or  arrow buttons until the display reads: $\begin{matrix} \text{10} \\ \text{ULOC} \end{matrix}$.
24. Press . until the display reads: $\begin{matrix} \text{10} \\ \text{b,RS} \end{matrix}$. If it doesn't, Press the  or  arrow buttons until the display reads: $\begin{matrix} \text{10} \\ \text{b,RS} \end{matrix}$.



25. Press  until the display reads: $\begin{matrix} 475 \\ SPUL \end{matrix}$. If it doesn't, Press the  or  arrow buttons until the display reads: $\begin{matrix} 475 \\ SPUL \end{matrix}$.

26. Press  until the display reads: $\begin{matrix} 60 \\ SPUL \end{matrix}$. If it doesn't, Press the  or  arrow buttons until the display reads: $\begin{matrix} 60 \\ SPUL \end{matrix}$.

27. Press  until the display reads: $\begin{matrix} | \\ Ct | \end{matrix}$. If it doesn't, Press the  or  arrow buttons until the display reads: $\begin{matrix} | \\ Ct | \end{matrix}$.

28. Press  until the display reads: $\begin{matrix} d.5R \\ RPt \end{matrix}$. Press the  or  arrow buttons until the display reads: $\begin{matrix} EnRb \\ RPt \end{matrix}$.

Turn OFF the machine. Wait 5 seconds and turn on the machine.

29. Press . The display will read: $\begin{matrix} 80 \\ SP \end{matrix}$. Press the  or  arrow buttons to change the temperature to the required setting.

30. Press  to save the change.

Turn OFF the machine. Wait 5 seconds and turn on the machine.

(if the setup is correct, the "AT" light on the controller will be flashing)

Allow the machine to warm up to operating temp. This completes the controller setup. The machine is now ready to operate.

Touch control board adjustment procedure

1. Check all of the wiring to the Touch board for loose or broken connections.
2. Turn on the machine and allow it to warm up.
3. Remove the touch guard sensor wire from the Sensor input connector.
4. Turn the Sensor detect adjustment screw until the Sensor detect light turns on.
5. Reconnect the touch guard sensor wire to the Sensor input connector. The Sensor detect light should go out.
6. Adjust the Trigger adjustment until the Trigger light turns on when you touch the bar with One finger.
7. Adjust the Delay adjustment so the machine cannot operate until after the sealing iron has returned to Up position.

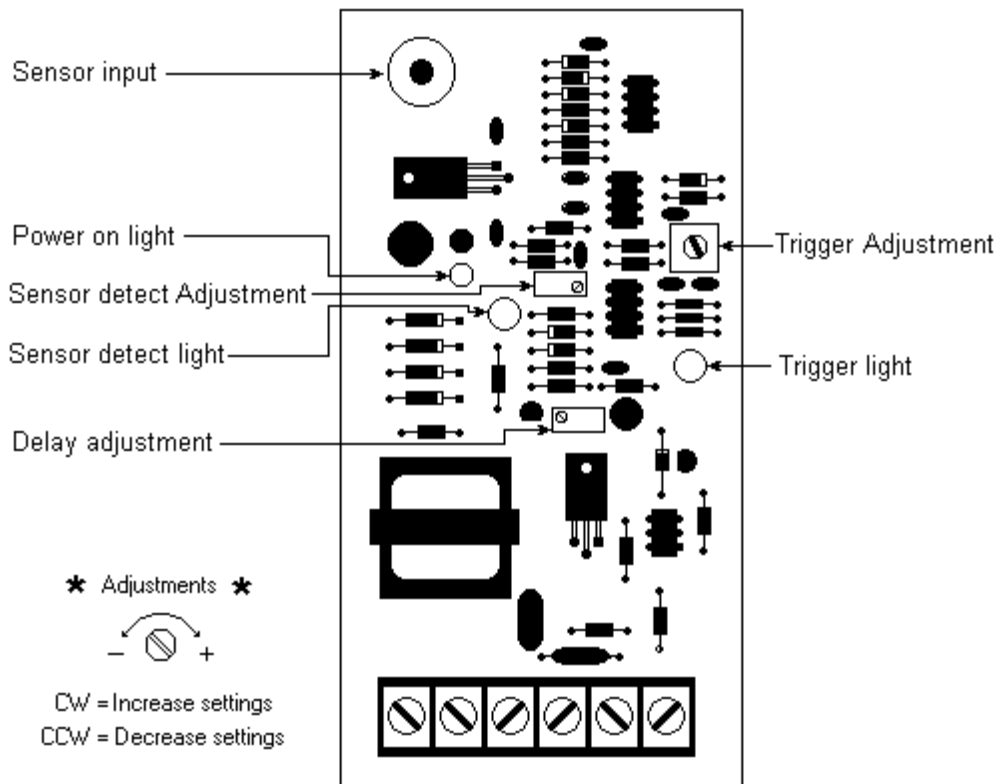

LOW AIR PRESSURE SWITCH

This machine is equipped with a Low Air Pressure Switch. Unless otherwise specified the pressure switch is factory set at 20 psi, this means that, if the supply air falls below 20 psi, the machine will not operate.

If the intent is to use this switch to shut down the operation, to prevent unsatisfactory seals, when supply line air pressure falls:

Then adjust the pressure switch to be, lets say, 5 psi less than the established air pressure regulator guage reading, lets say 60 psi.

Now the pressure switch can be set at 55 psi. Rotate thumb wheel, see below, to increase or decrease the setting to 55 psi.

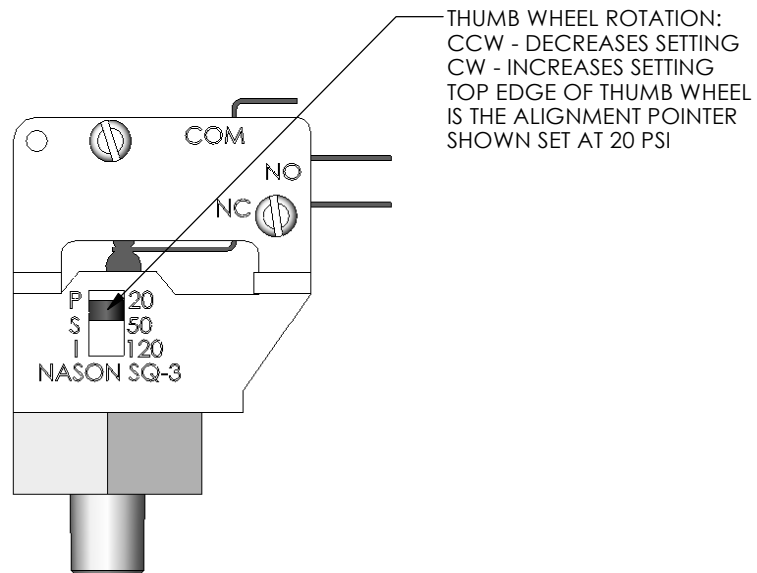

PRESSURE SWITCH, 20 - 120 PSI, 70166
SEE PAGE P-3 FOR ASSEMBLY DRAWING
REMOVE REAR COVER OF MACHINE TO ADJUST SWITCH



Natmar Services Company

139 Beattie Street • P.O. Box 6743 • Syracuse, NY 13217

Toll Free 800-798-8206 • Local (315) 445-2419 • Fax (315) 445-8046

www.natmar-nsc.com

Delay Timer Safety Feature

This unit is equipped with a delay timer. This circuitry safeguards the operator so that the actuator (either the push buttons or the foot pedal) must be held until the upper head is completely lowered. The operator therefore cannot depress the push buttons, and then move his or her hands under the upper head, which is being lowered. The operator should be particularly careful to keep his or her hands clear of the heating heads when utilizing a foot pedal with this unit.

Should the operator release the actuator before the upper and lower heads have met, the upper head will immediately rise to its upper position. When the upper head has risen to the upper position, the operator can again depress the actuator and hold it until the upper head lowers completely.



Natmar Services Company

139 Beattie Street • P.O. Box 6743 • Syracuse, NY 13217

Toll Free 800-798-8206 • Local (315) 445-2419 • Fax (315) 445-8046

www.natmar-nsc.com

**Foot Switch Assembly
70134
(Optional)**

At your request, this machine is equipped with the optional foot switch assembly (# 70134)

---NOTE---

PLEASE READ THE WARNING ATTACHED BEFORE PLACING THE MACHINE BACK IN OPERATION.

The foot switch must be attached to the machine before placing the machine in operation. A quick disconnect plug has been provided for your convenience. Plug the foot switch cable into the receptacle located at the right rear of the machine.

Normal operation of the machine would require the operator to push both green buttons simultaneously and hold them in until the head closes completely, and the main timer (#2860) begins to count down. The operation sequence requires the use of both hands and is designed as a safety feature of the machine.

Use of the foot switch overrides the function of the two green buttons and negates this safety feature. The foot switch must also be depressed and held until the heads close completely, and the main timer (#2860) begins to count down.

The safety touch bar is still operational and is the only safety against operator injury.

---WARNING---

For safety reasons, NATMAR Services Company does not recommend the use of the foot switch on this machine.

It is the responsibility of the user to determine the suitability of a foot control and to provide adequate training in the safe operation of the machine.

NATMAR Services Company will not accept responsibility for damage or injury resulting from the use of the foot switch.

FOOT SWITCH W/GUARD
Part No. 70134

**MFG.- CONNTROL INTERNATIONAL
ASSEMBLED**

**CONNTROL #
864-1000-00**

**CONNTROL # 892-1330-01
FOOT SWITCH W/CORD & PLUG**

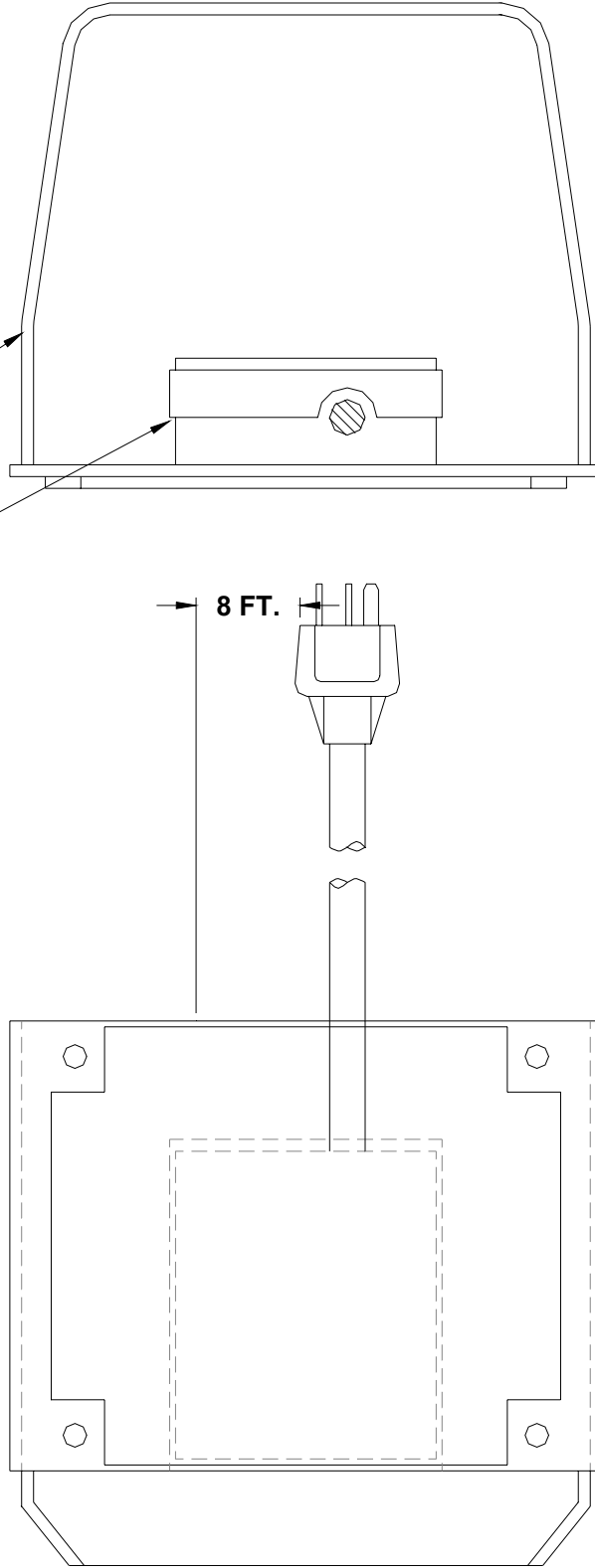

FOR CUSTOMER SERVICE

**20056-04 FOOT SWITCH W/CORD & PLUG
20056-05 GUARD**

**FOR SERIAL # 2148 AND BELOW USE # HA03
FOR SERIAL #2149 AND ABOVE USE # 70134**

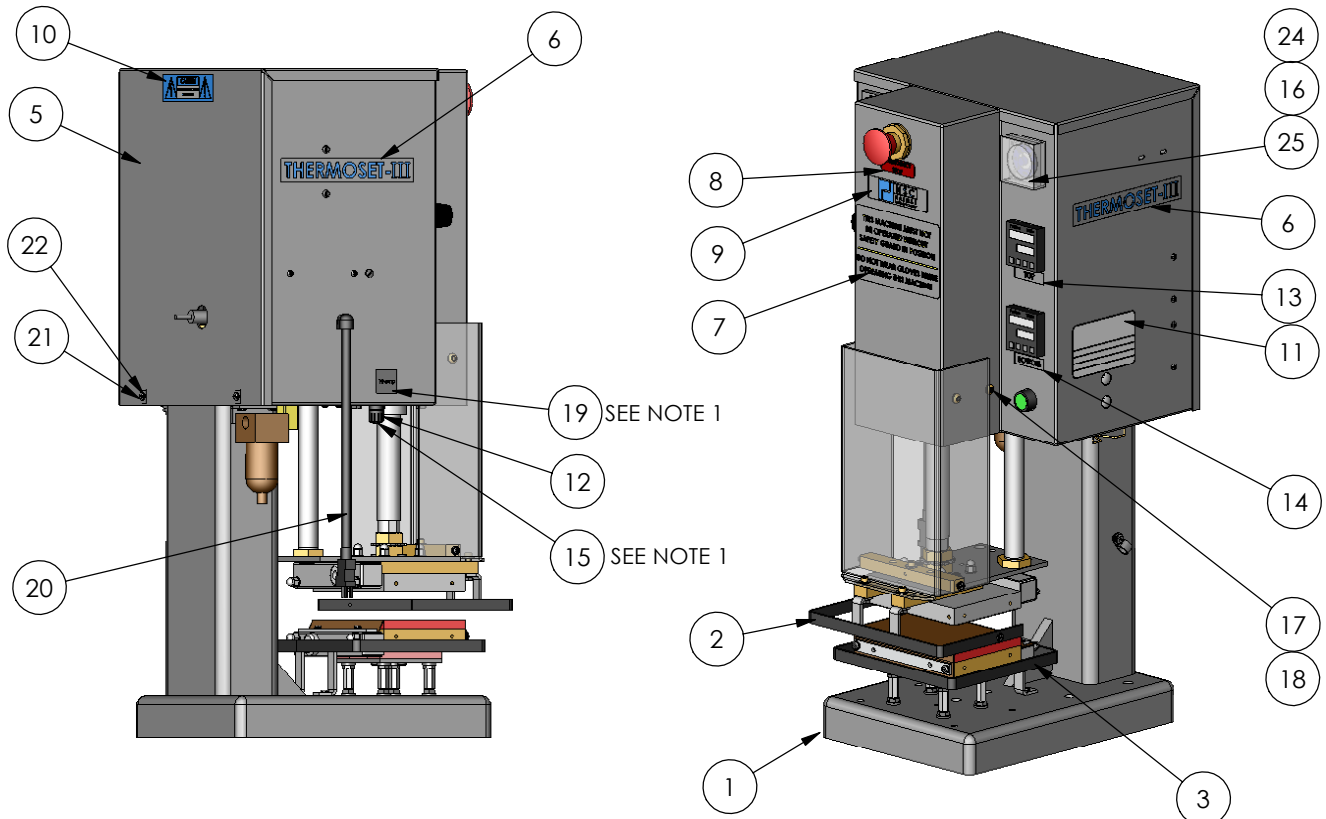

ITEM NO.	PART NUMBER	DESCRIPTION	QTY.
1	FRAME ASSY 4inB CYL	SEE PAGE M-2	1
2	UPPER HEAD 4X6 120V	SEE PAGE M-4	1
3	LOWER HEAD 4X6 120V	SEE PAGE M-5	1
4	FRONT COVER ASSY HS171	SEE PAGE M-6	1
5	70173	BACK COVER	1
6	70175	DECAL, THERMOSET III	2
7	2856	WARNING LABEL	1
8	42926	LABEL, EMERGENCY STOP	1
9	2873	NATMAR DECAL	1
10	3322	ELECTRIC CAUTION DECAL	1
11	21977	LABEL, MODEL AND SERIAL NO.	1
12	9696	FUSE HOLDER 10 AMP MAX	1
13	70158T	LABEL, TOP	1
14	70158B	LABEL, BOTTOM	1
SEE NOTE 1	15	1734 FUSE, 10 AMP 250V TIME DELAY .25 X 1.25	1
	16	2861 SOCKET FOR TIMER	1
	17	21061-02-F BUTTON HD SCR 1/4 - 20 X 3/8 LONG	4
	18	21021-09-A L'W - INT NO. 1/4	4
SEE NOTE 1	19	70098 LABEL, FUSE WARNING, 10 AMP	1
	20	1695 POWER CORD 13 AMP 16GA	1
	21	21029-15 PHS 8-32 X 5/8 LG SELF THD	2
	22	21021-06-A L'W - INT NO. 8	2
	23	70184 TIMER, ALLEN-BRADLEY	1
	24	70185 CLIP, RETAINER	1
	25	70186 SHIELD, PLASTIC	1

NOTE 1: FOR A 240V MACHINE, HS172-1, USE FUSE #1741A, 5 AMP AND FUSE LABEL, #46068

**HS171-1 THERMOSET III SHOWN
M-1**

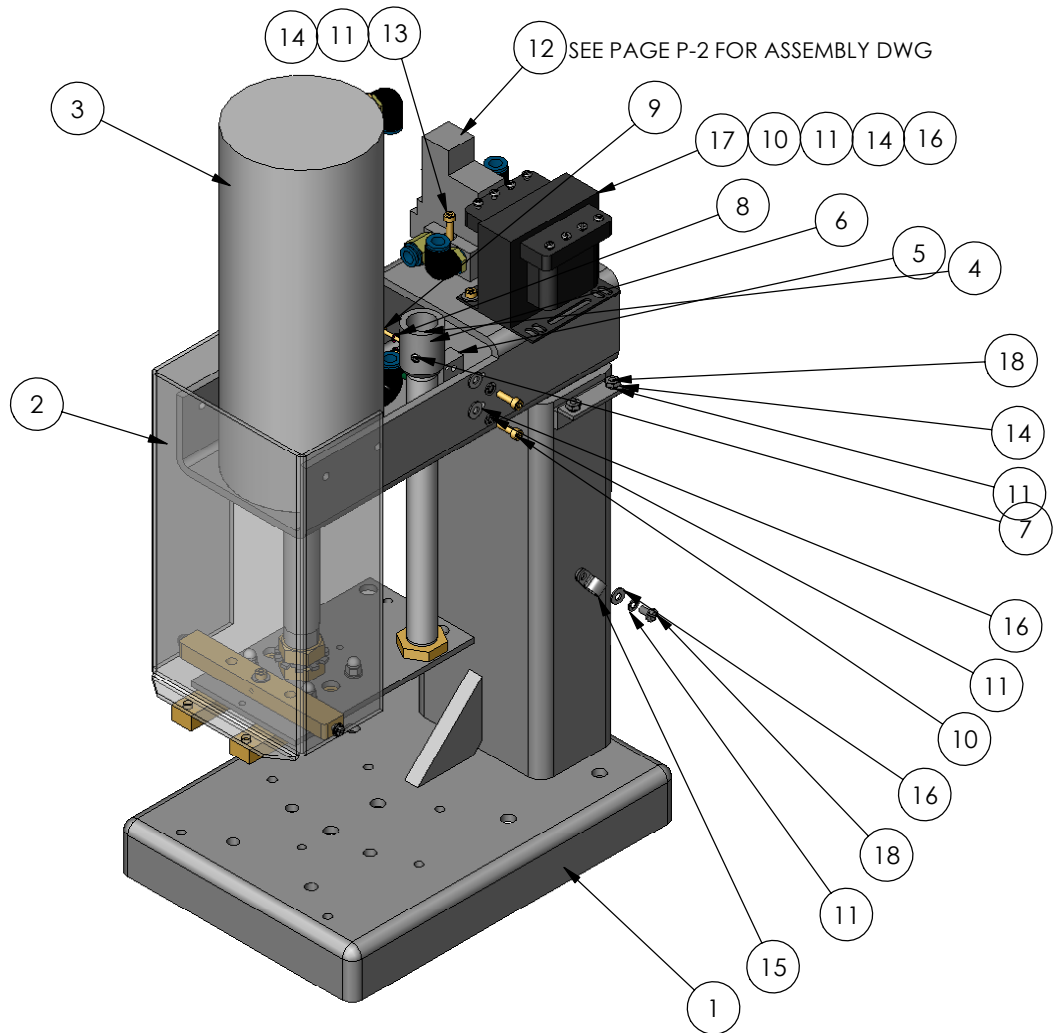

ITEM NO.	PART NUMBER	DESCRIPTION	QTY.
1	30439	WELDMENT, THERMOSET FRAME	1
2	UPPER HEAD MOUNTING 4in B	SEE PAGE M-3	1
3	AIR CYL ASSY, 4 X 7	SEE PAGE P-1	1
4	70170	COLLAR, SWITCH ACTUATOR	1
5	70171	BLOCK, SWITCH MOUNTING	1
6	20055-62	SWITCH - MICRO	1
7	21011-05-L	SET SCW - CUP 1/4-20 X 1/4 LG	1
8	21021-03-A	L'W - INT NO 4	2
9	21057-08-C	RHS 4-40 X 5/8 LG	2
10	21063-05-J	SHCS - 10-32 X 5/8 LONG	4
11	21021-07-A	L'W - INT NO. 10	11
12	70151	AIR VALVE ASSY 4" BORE CYL	1
13	21063-09-J	SHCS - 10-32 X 1 1/4 LONG	2
14	21051-09-A	NUT - #10-32	8
15	D-1454	CLAMP - 3/8 CABLE	1
16	21023-01	F'W - #10	5
17	3315	TRANSFORMER	1
18	21058-05-H	PHS 10-32 X 3/8 LG	5

SEE NOTE 1

NOTE 1: TRANSFORMER,3315 REQUIRED ON 240V MACHINES ONLY.

FRAME ASSEMBLY W/4" BORE CYL
M-2

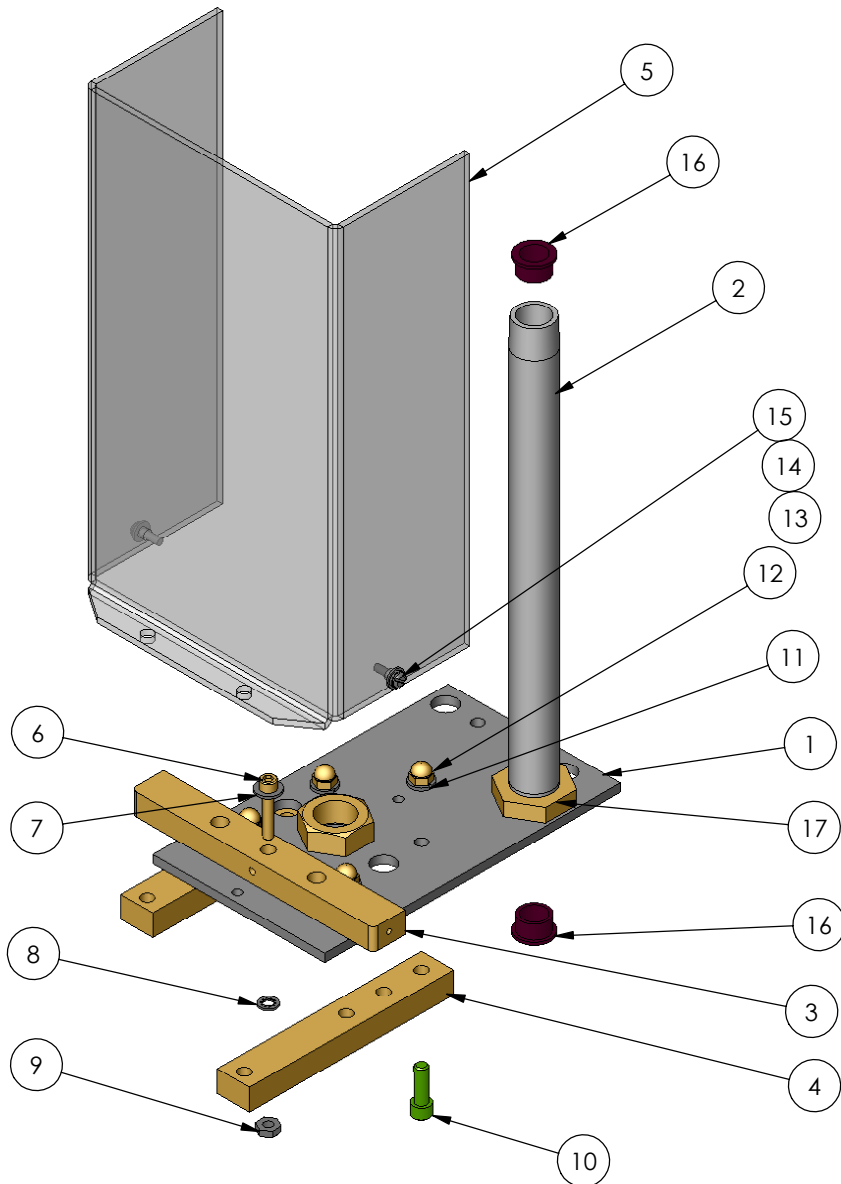

ITEM NO.	PART NUMBER	DESCRIPTION	QTY.
1	32013	MOUNTING PLATE, UPPER HEAD, 4" BORE	1
2	28231	GUIDE ROD	1
3	22046	SUPPORT, PLASTIC GUARD	1
4	32256	INSULATOR, UPPER BAR	2
5	28315	GUARD, PLASTIC TS I, II, III	1
6	21063-08-J	SHCS - 10-32 X 1.0 LONG	1
7	21023-01	F'W - #10	1
8	21021-07-A	L'W - INT NO. 10	1
9	21051-09-A	NUT - #10-32	1
10	21063-06-K	SHCS 1/4 - 20 X 3/4 LG	4
11	21021-09-C	L'W - SPLIT 1/4	4
12	1200	ACORN HEX NUT 1/4-20	4
13	21023-22	WASHER - FLAT NO. 6	2
14	21021-05-A	L'W - INT NO. 6	2
15	21058-07-E	PHS - 6-32 X 1/2 LG	2
16	24004-21	GROMMET - PLASTIC	2
17	21945A	LOCKNUT 1/2 NPT HEX BRASS	1

**UPPER HEAD MOUNTING, 4" BORE CYL
M-3**

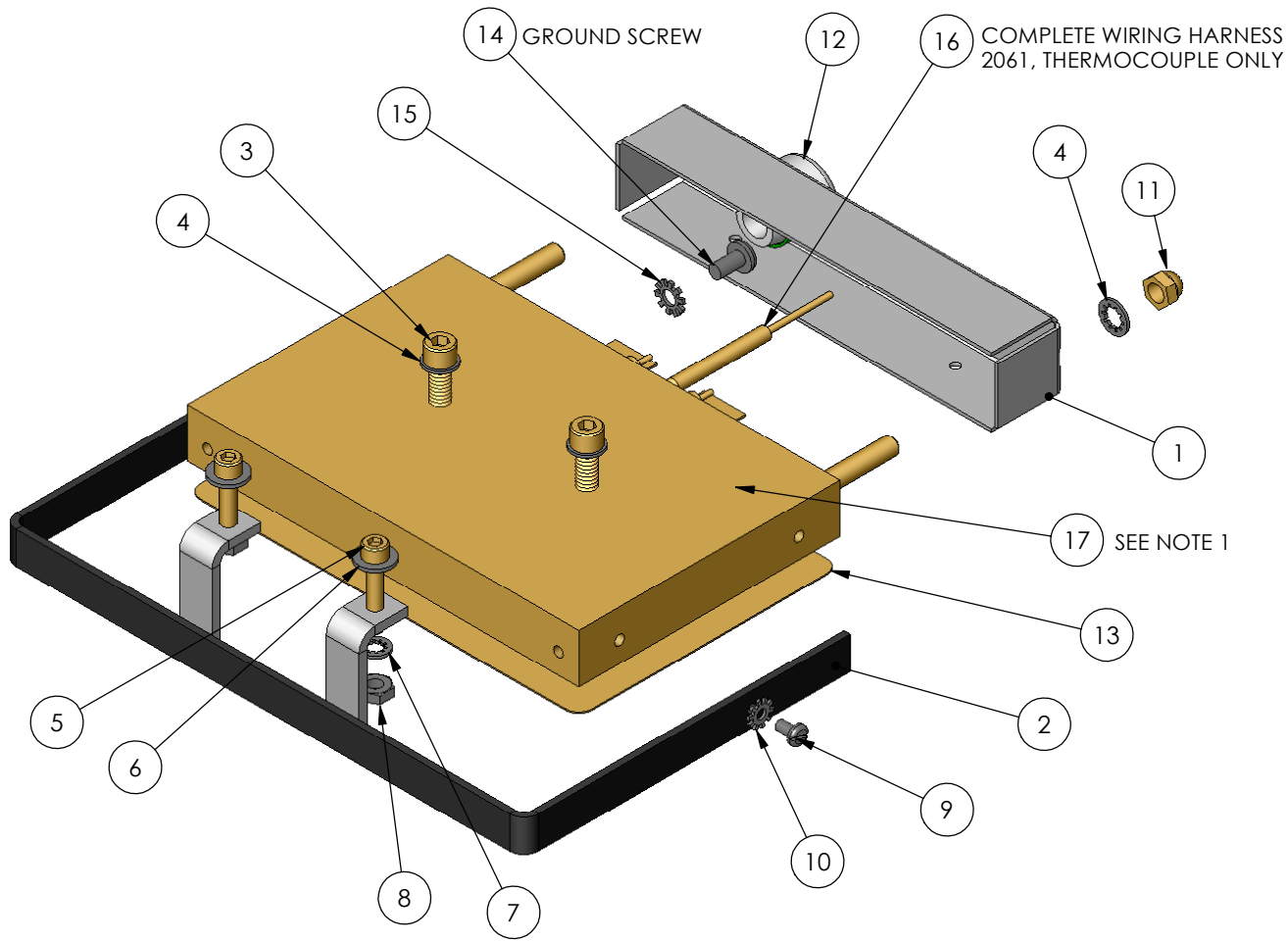

ITEM NO.	PART NUMBER	DESCRIPTION	QTY.
1	36165	WIRE COVER, 4X6	1
2	30344	SAFETY BAR, UPPER 6X10	1
3	21063-08-K	SHCS 1/4-20 X 1.0 LG	2
4	21021-09-A	L'W - INT NO. 1/4	4
5	21063-08-J	SHCS - 10-32 X 1.0 LONG	2
6	21023-01	F'W - #10	2
7	21021-07-A	L'W - INT NO. 10	2
8	21051-09-A	NUT - #10-32	2
9	21058-03-E	PHS 6 - 32 X 1/4 LG	1
10	21021-05-B	L'W - EXT NO. 6	1
11	1200	ACORN HEX NUT 1/4-20	2
12	1676	CERAMIC BUSHING W/SPRING	1
13	70062-B	TEFLON W/PSA 4X6	1
14	21058-05-G	PHS 10-24 X 3/8 LG	1
15	21021-07-B	L'W - EXT NO. 10	1
16	30990	WIRING HARNESS, HEATER	1
17	23180A	HEATER 4X6, 120V	1

SEE NOTE 1

NOTE 1: FOR A 240V MACHINE USE HEATER, #23181A

**UPPER HEAD ASSEMBLY 4X6, 120V SHOWN
M-4**

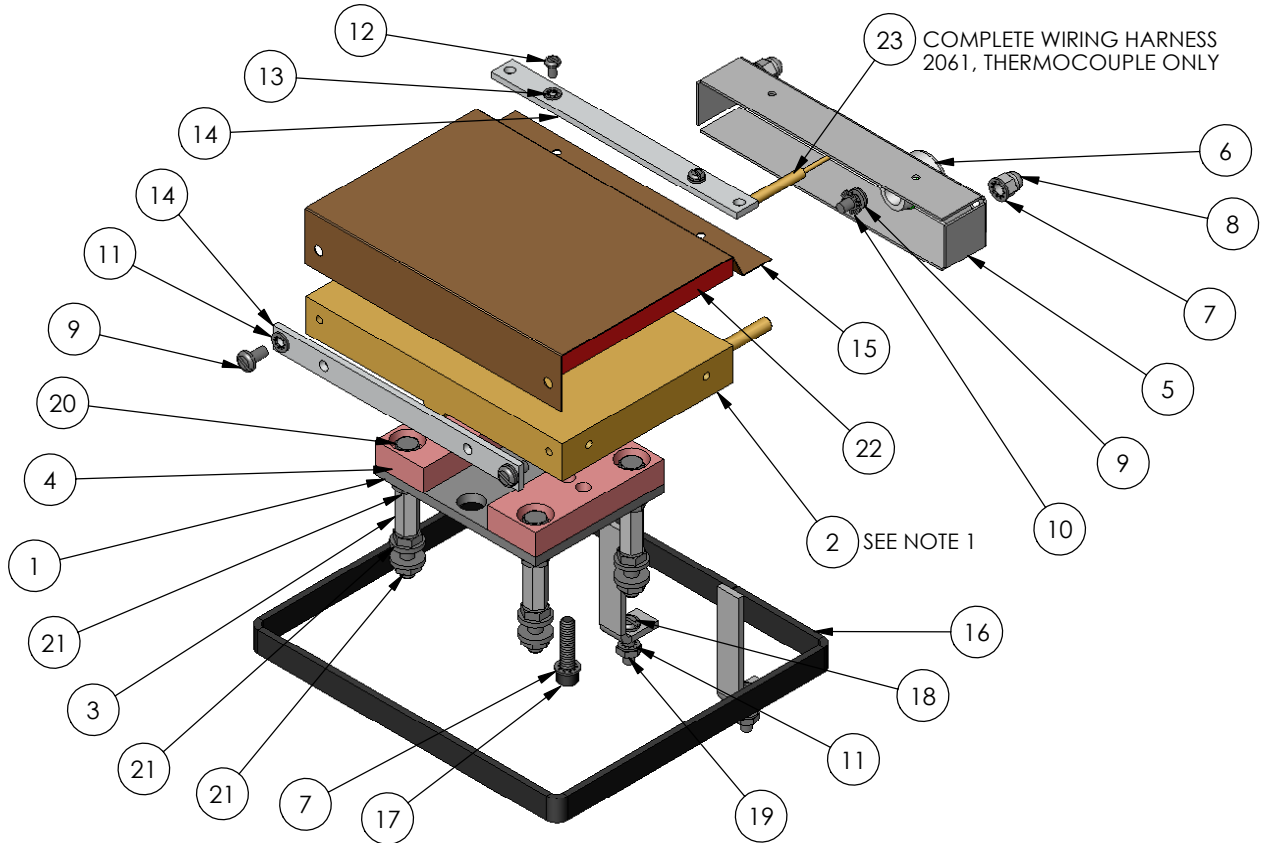

SEE NOTE 1

ITEM NO.	PART NUMBER	DESCRIPTION	QTY.
1	23673	MOUNTING PLATE, LOWER HEAD	1
2	23180	HEATER 4X6, 120V	1
3	9770	HEX COUPLING, 3/8X7/8LG #1/4-20	4
4	22012	BOTTOM HEAT INSULATOR	2
5	36165	WIRE COVER, 4X6	1
6	1676	CERAMIC BUSHING W/SPRING	1
7	21021-09-A	L'W - INT NO. 1/4	4
8	1200	ACORN HEX NUT 1/4-20	2
9	21058-05-G	PHS 10-24 X 3/8 LG	3
10	21021-07-B	L'W - EXT NO. 10	1
11	21021-07-A	L'W - INT NO. 10	4
12	21058-03-E	PHS 6 - 32 X 1/4 LG	2
13	21021-05-A	L'W - INT NO. 6	2
14	20425	PLATE, TEFLON CLAMP	2
15	23996-A	TEFLON W/OUT PSA 4X6	1
16	32298	WELDMENT, 4X6 LOWER SAFETY BAR	1
17	21063-08-K	SHCS 1/4-20 X 1.0 LG	2
18	21058-09-H	PHS 10-32 X 3/4 LG	2
19	21051-09-A	NUT - #10-32	2
20	1260	HHCS 1/4-20 X 2 1/2 LG	4
21	1986	HEX WIZ NUT 1/4 - 20	12
22	26108	PAD, FIRM 3/8 X 4 X 6	1
23	30990	WIRING HARNESS, HEATER	1

NOTE 1: FOR A 240V MACHINE, USE HEATER #23181

**LOWER HEATER 4X6, 120V SHOWN
M-5**

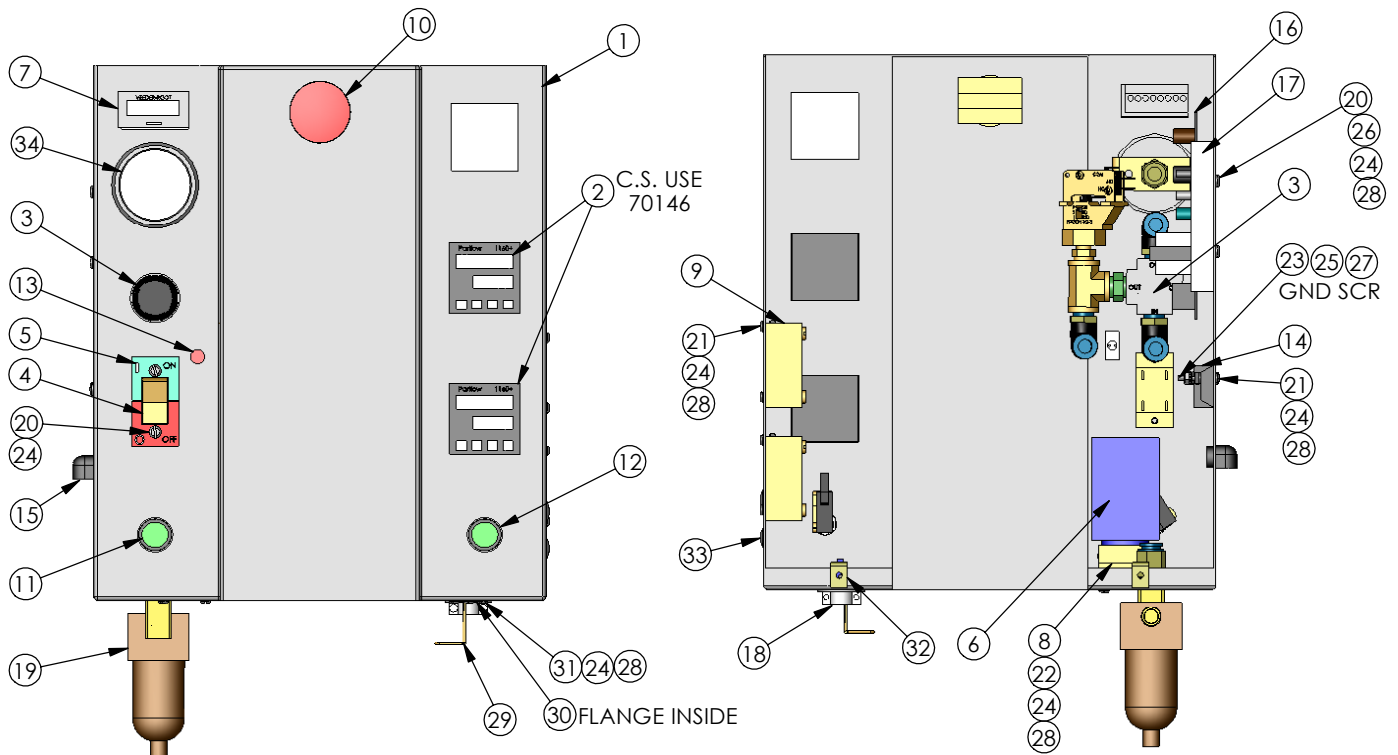

C.S. USE 70146

ITEM NO.	PART NUMBER	DESCRIPTION	QTY.
1	70172	FRONT COVER	1
2	70145	TEMPERATURE CONTROL, DIGITAL	2
3	AIR REGULATOR ASSY	SEE PAGE P-3	1
4	2150	ROCKER SWITCH	1
5	2225	ON/OFF PLATE	1
6	3300	ANTI TIE DOWN RELAY	1
7	70174	COUNTER, 1/32 DIN VEEDER	1
8	3301	SOCKET, 8 PIN	1
9	3568	SOLID STATE RELAY	2
10	2569	"E" STOP SWITCH	1
11	START SWITCH ASSY, LEFT	SEE PAGE M-8	1
12	START SWITCH ASSY, RIGHT	SEE PAGE M-8	1
13	2044	RED PILOT LIGHT	1
14	1660	TERMINAL STRIP - 6 POS	1
15	1630	STRAIN RELIEF BUSHING	1
16	2025	TOUCH CONTROL BOARD	1
17	2053	SNAPTRACK, C.B. MOUNT	1
18	1624	CONNECTOR, 3/8 ROMEX	1
19	AIR FILTER ASSY	SEE PAGE P-4	1
20	21058-05-F	PHS 8-32 X 3/8 LG	4
21	21058-08-E	PHS - 6-32 X 5/8 LG	6
22	21058-11-E	PHS - 6-32 X 1.0 LG	2
23	21060-11-F	BHS NO. 8-32 X 1.0 LG	1
24	21021-05-A	L'W - INT NO. 6	16
25	21021-06-B	L'W - EXT NO. 8	4
26	21023-22	WASHER - FLAT NO. 6	2
27	21051-07-A	HEX NUT - NO. 8-32	4
28	21051-06-A	HEX NUT - #6-32	14
29	70136	PLUG RETAINER	1
30	70181	SOCKET, 3 TERMINALS	1
31	21058-05-E	PHS - 6-32 X 3/8 LG	4
32	21029-09	NUT, SPEED #8 STYLE H	2
33	21050-47	SNAP PLUG 1/2"	2
34	AIR GAUGE ASSY	SEE PAGE P-4	1

FRONT COVER ASSEMBLY HS171
M-6

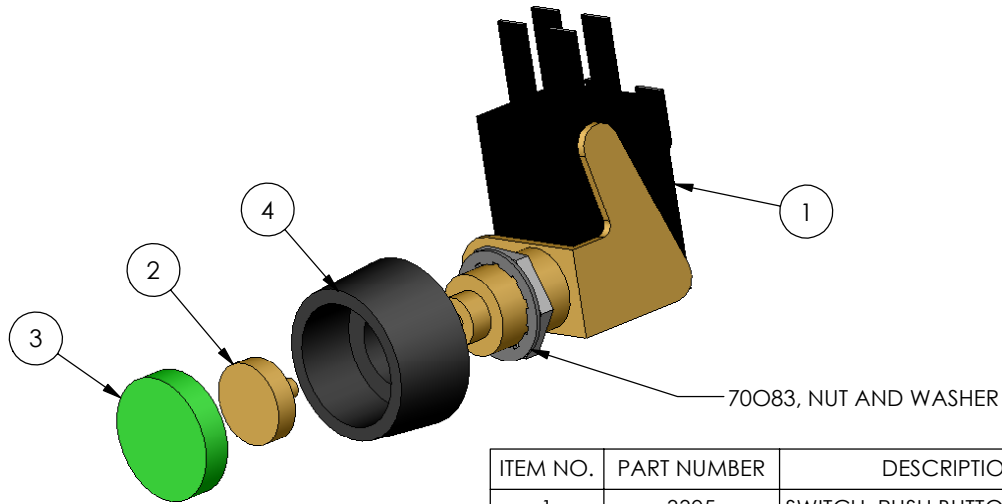

ITEM NO.	PART NUMBER	DESCRIPTION	QTY.
1	3305	SWITCH, PUSH BUTTON, DOUBLE	1
2	3015	SCREW ADAPTOR	1
3	2824	GREEN START BUTTON	1
4	2825	BEZEL, START BUTTON	1

START SWITCH ASSEMBLY, LEFT

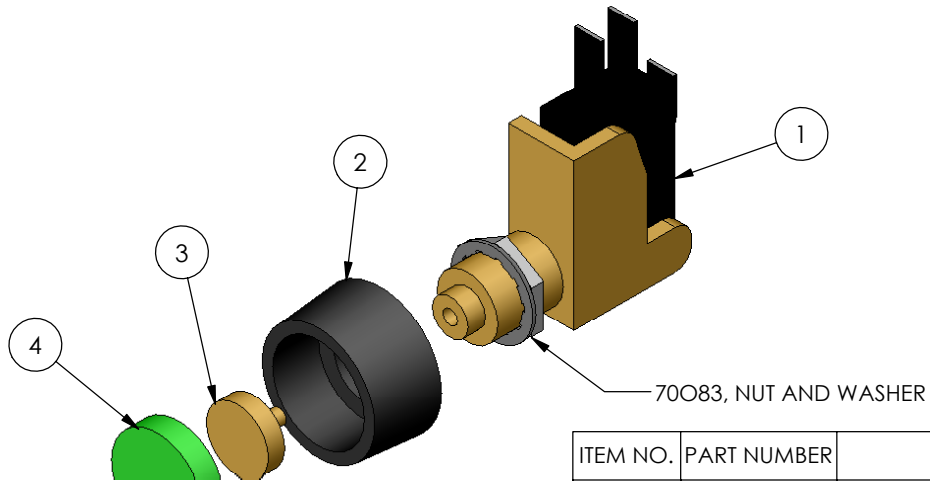

ITEM NO.	PART NUMBER	DESCRIPTION	QTY.
1	2823	SWITCH, PUSH BUTTON, SINGLE	1
2	2825	BEZEL, START BUTTON	1
3	3015	SCREW ADAPTOR	1
4	2824	GREEN START BUTTON	1

START SWITCH ASSEMBLY, RIGHT

M-9

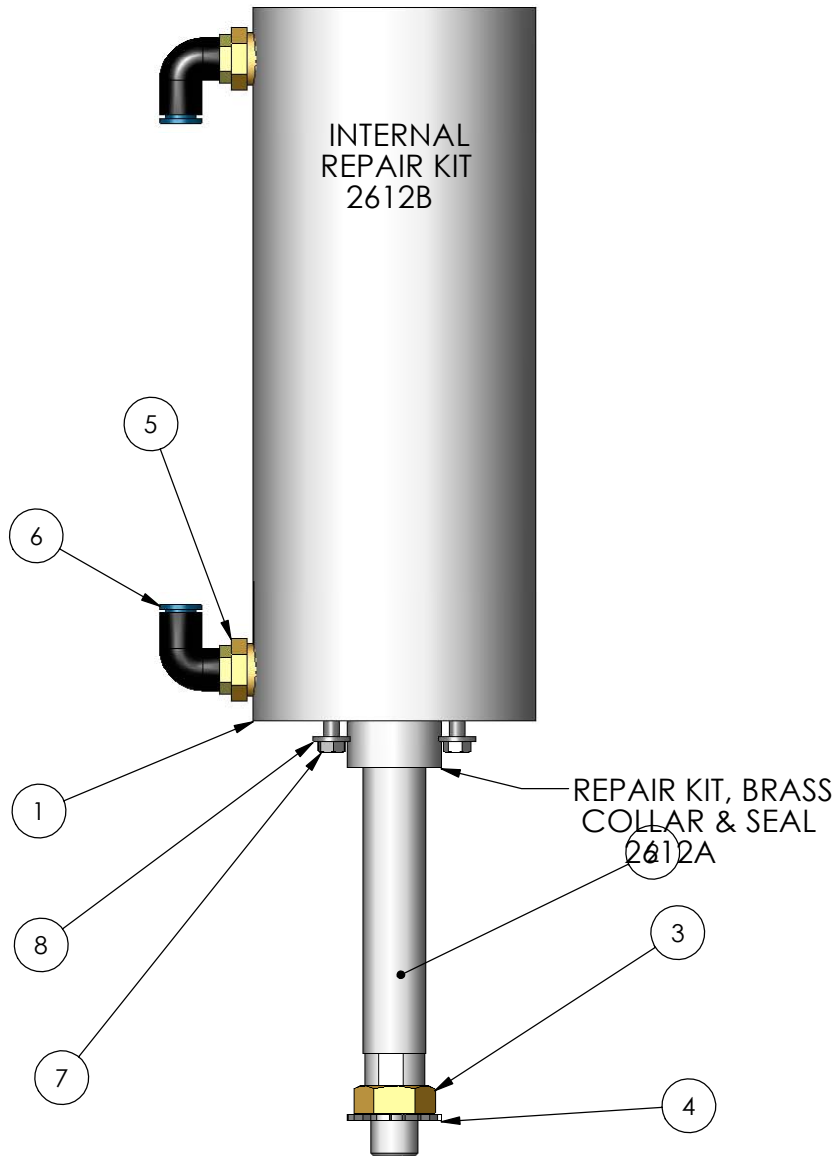

ITEM NO.		DESCRIPTION	QTY.
1	2352	AIR CYLINDER 4"BORE 7"STROKE	1
2	2352S	PART OF 2352	1
3	2353	HEX JAM NUT 3/4-16	1
4	21021-16-B	L'W - EXT NO. 3/4	1
5	9442	REDUCING BUSHING 1/2MPT X 1/4FPT	2
6	22015-34	ELBOW - 1/4 MPT X 3/8 TUBE	2
7	HHCS .31-18 X 1.0 LG	SUPPLIED W/AIR CYLINDER	4
8	21021-10-C	L'W #5/16 SPLIT	4

AIR CYLINDER ASSEMBLY 4" BORE X 7" STROKE

P-1

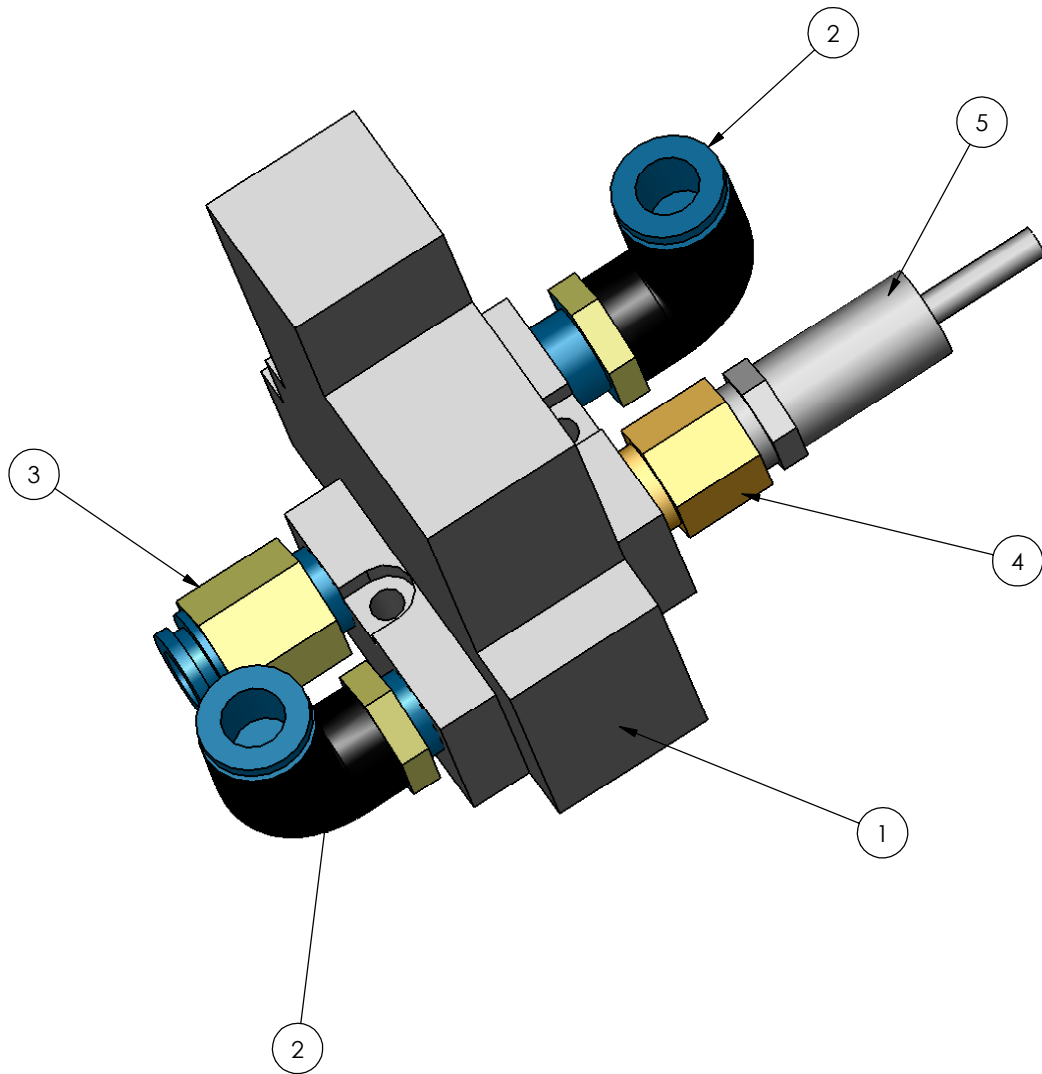

ITEM NO.	PART NUMBER	DESCRIPTION	QTY.
1	2324	PENUMATIC SOLENOID VALVE 120V	1
2	22015-34	ELBOW - 1/4 MPT X 3/8 TUBE	2
3	20107	CONN - 1/4 MPT X 3/8 TUBE	1
4	20113	ADAPTER 1/4 FPT X 1/4 MPT	1
5	2339	MUFFLER, SPEED CONTROL	1

70151 COMPLETE VALVE ASSEMBLY FOR 4" BORE CYL

P-2

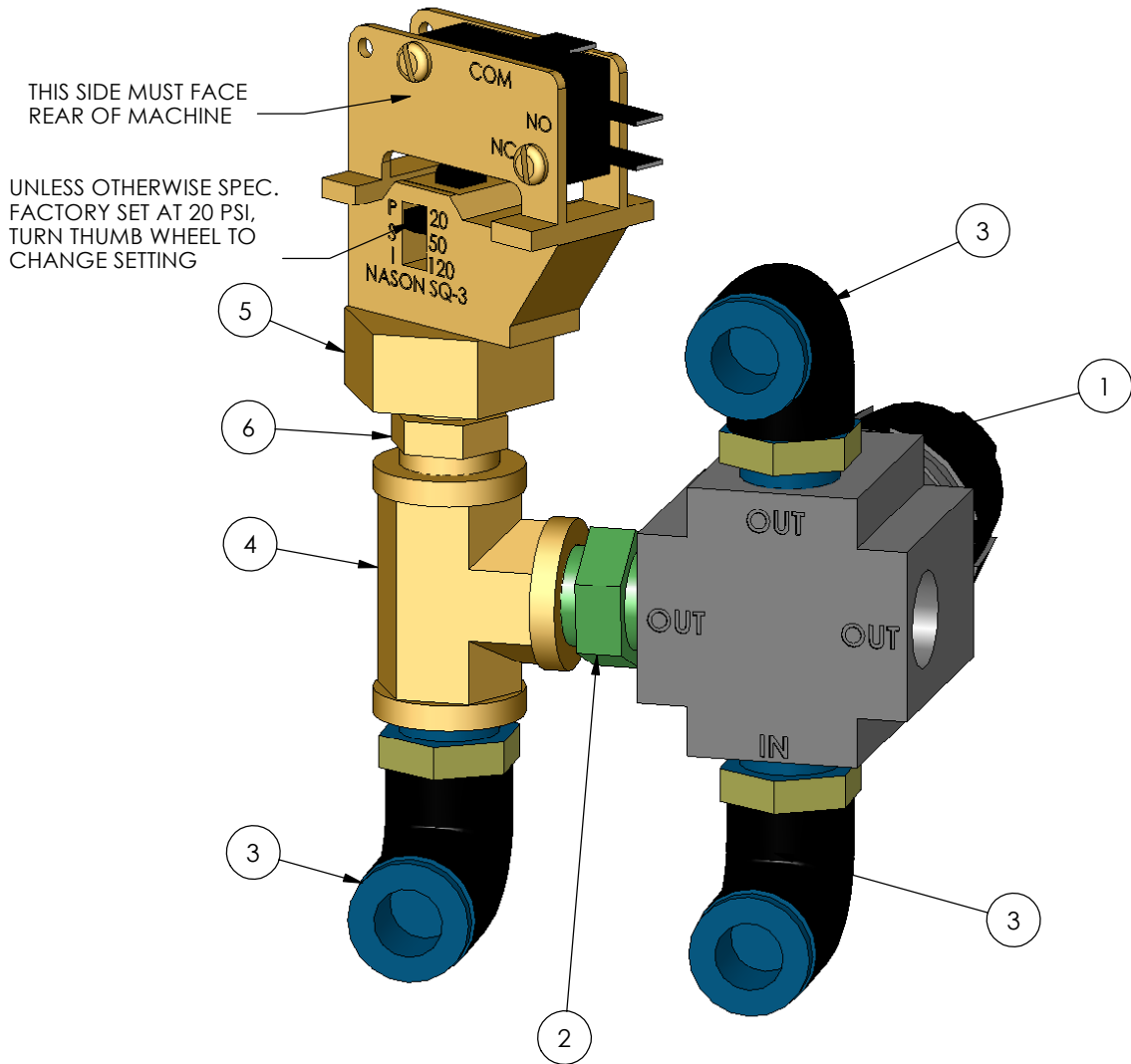

ITEM NO.	PART NUMBER	DESCRIPTION	QTY.
1	20066	AIR REGULATOR W/MOUNTING NUT	1
2	DH-6786	NIPPLE - HEX 1/4 MPT	1
3	22015-34	ELBOW - 1/4 MPT X 3/8 TUBE	3
4	DH-6762	TEE 1/4FPT	1
5	70166	PRESSURE SWITCH, 20-120PSI	1
6	20114	BUSHING, 1/4MPT X 1/8FPT	1

AIR REGULATOR AND PRESSURE SWITCH ASSEMBLY

P-3

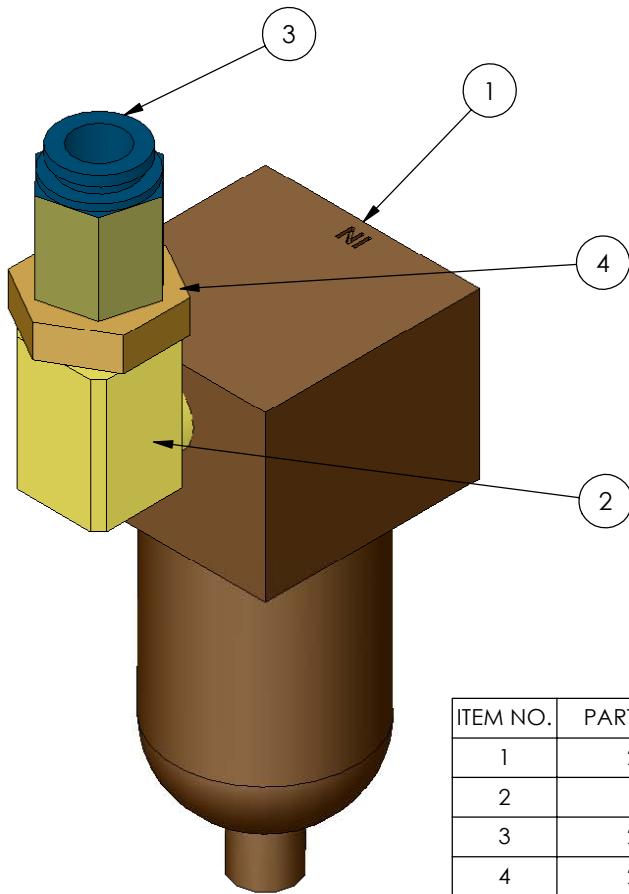

ITEM NO.	PART NUMBER	DESCRIPTION	QTY.
1	20078	AIR FILTER	1
2	1598	ELBOW, STREET, 90 deg. (BRASSCRAFT)	1
3	20107	CONN - 1/4 MPT X 3/8 TUBE	1
4	21945	LOCKNUT 1/4 NPT HEX BRASS	1

AIR FILTER ASSEMBLY

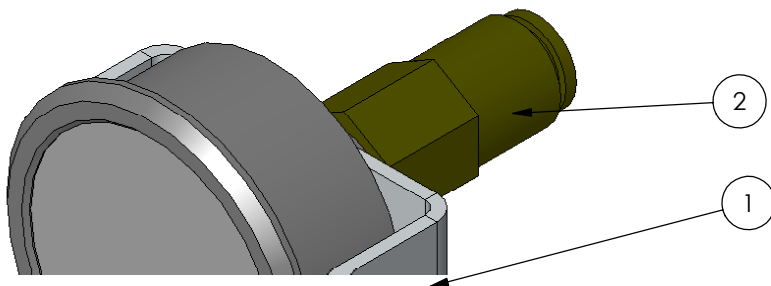

ITEM NO.	PART NUMBER	DESCRIPTION	QTY.
1	21983	AIR GAUGE	1
2	22030-45	CONN - 1/4 FPT X 3/8 TUBE	1

AIR GAUGE ASSEMBLY

P-4

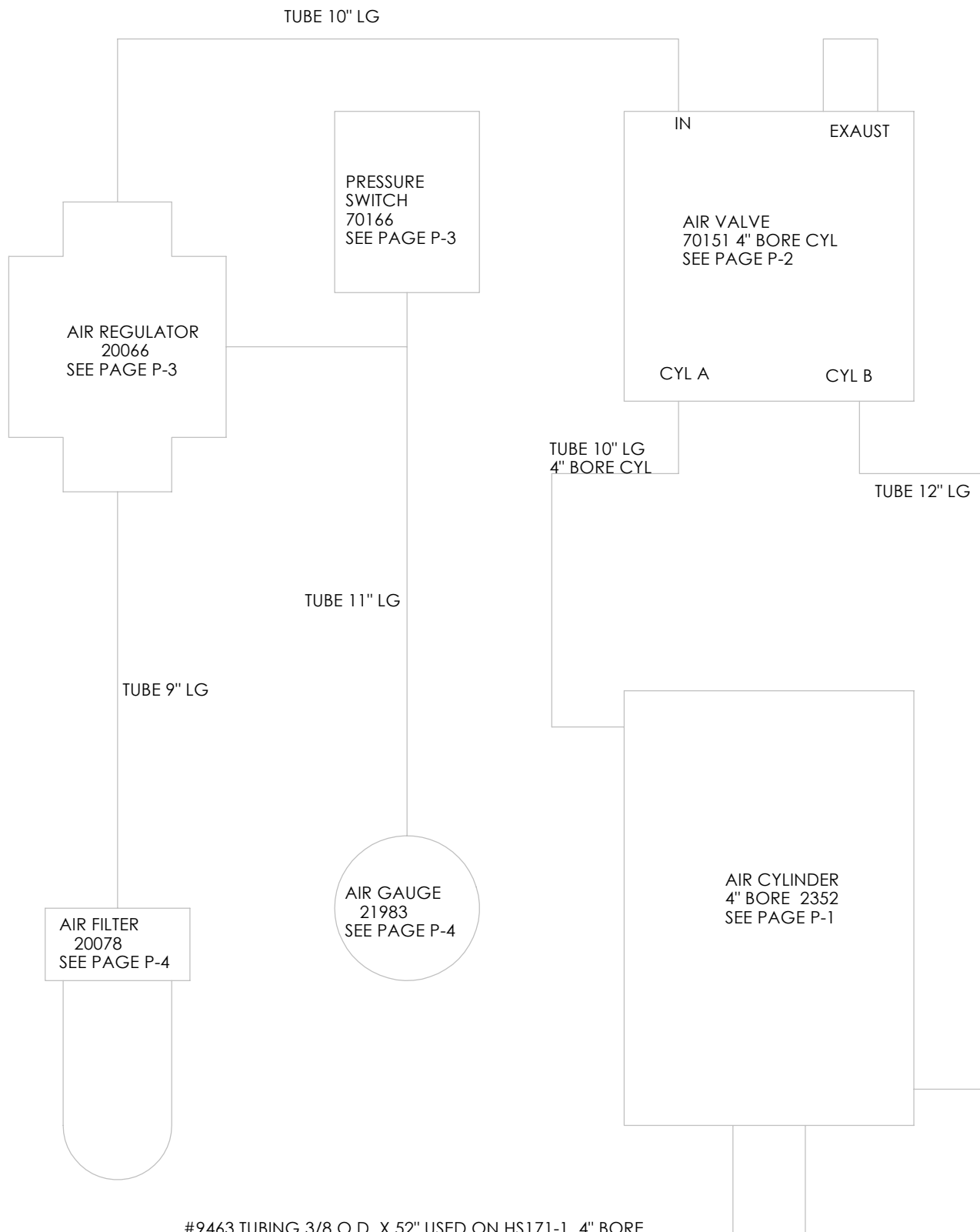

#9463 TUBING 3/8 O.D. X 52" USED ON HS171-1 4" BORE

CAUTION: WE RECOMMEND THAT NO OIL BE PLACED INTO THE AIR SYSTEM OF THIS MACHINE

PNEUMATIC DIAGRAM HS171 THERMOSET III

P-5

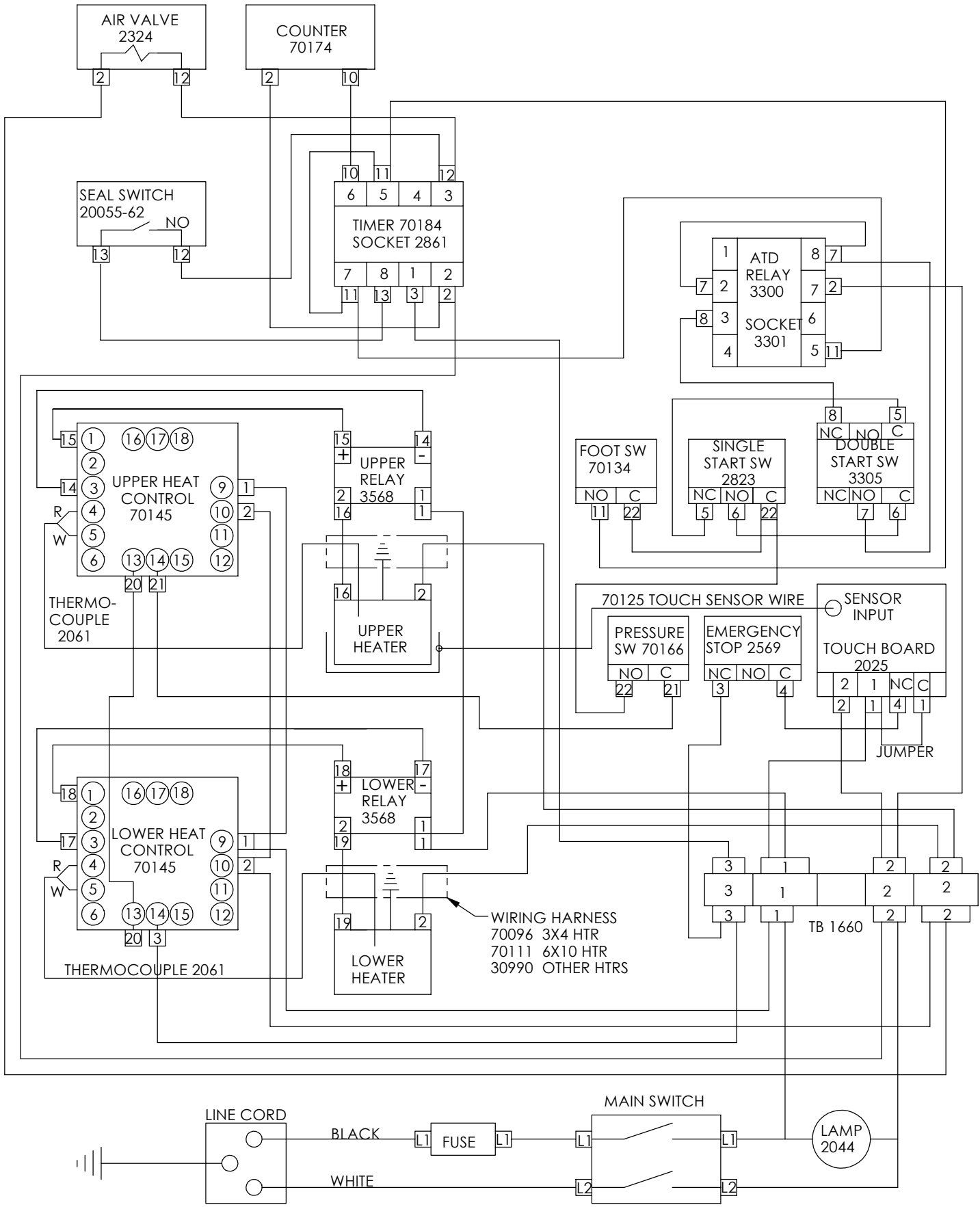

WIRING DIAGRAM HS171 120V

E-1

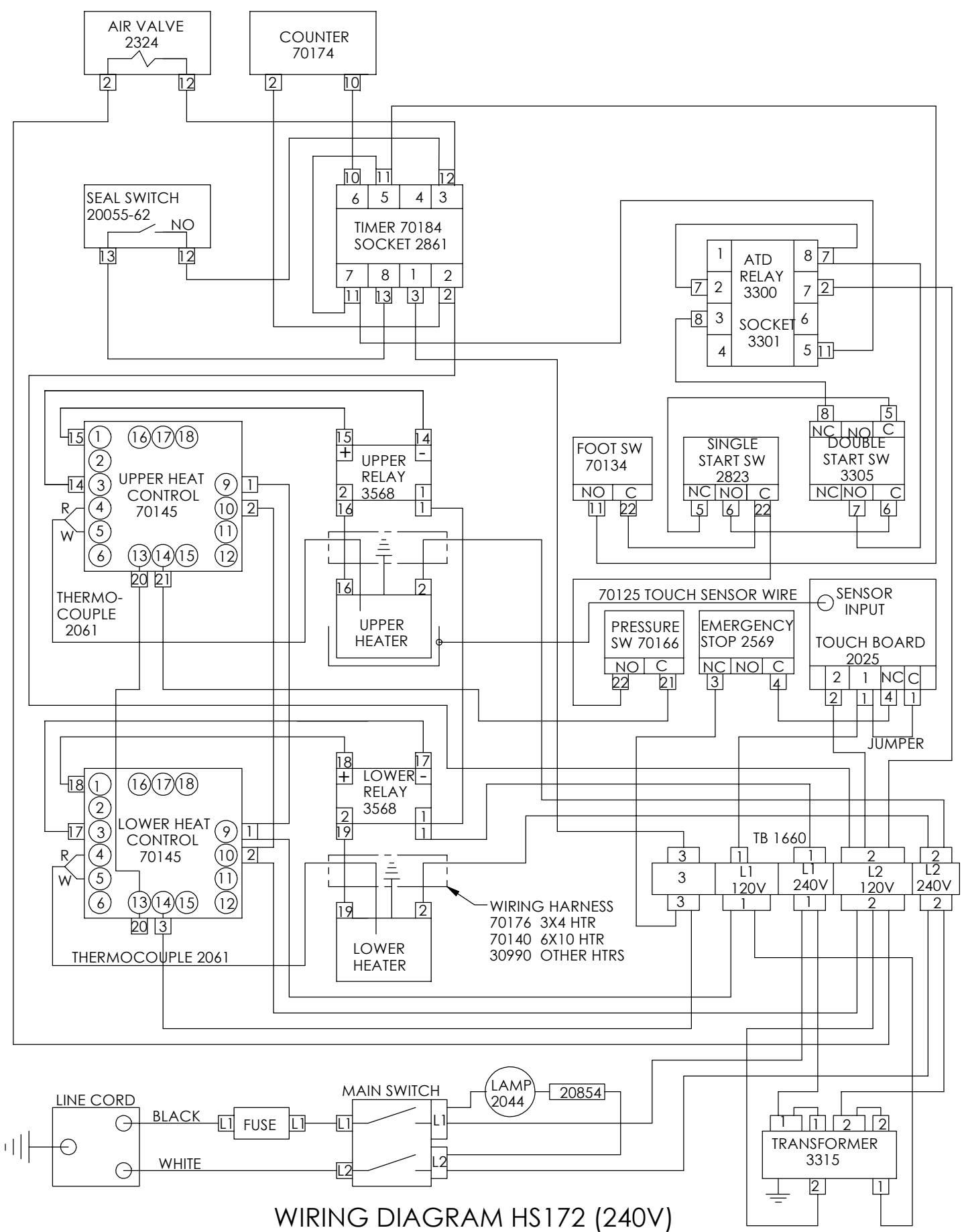



WIRING DIAGRAM HS172 (240V)

E-2



Setup instructions for a NEW controller (P/N: 70145)

When a **NEW** controller is connected and **powered on** for the **first time**, the display will read:

Go to
Conf.



1. Press . The display will read: $\overset{0}{ULoc}$. Press the  or  arrow

buttons until the display reads: $\overset{20}{ULoc}$.

2. Press . The display will read: $\overset{JF}{inPte}$. Press the  arrow



button until the display reads: $\overset{JF}{inPte}$. (The JF will flash)

3. Press . The JF will stop flashing.

4. Press  until the display reads: $\overset{P_Lo}{RLR2}$. Press the  or  arrow



buttons until the display reads: $\overset{band}{RLR2}$. (The BAND will flash)

5. Press . The BAND will stop flashing.

6. Press  until the display reads: $\overset{5}{bRL2}$. Press the  or  arrow



buttons until the display reads: $\overset{15}{bRL2}$. (The 15 will flash)

7. Press . The 15 will stop flashing.

8. Press  until the display reads: $\overset{\text{nonE}}{\text{inh}}$. If it doesn't, Press the  or  arrow



buttons until the display reads: $\overset{\text{ALR1}}{\text{inh}}$. (**The ALA1 will flash**)

9. Press . The ALA1 will stop flashing.

10. Press  until the display reads: $\overset{\text{PRI}}{\text{USE}}$. If it doesn't, Press the  or  arrow

buttons until the display reads: $\overset{\text{PRI}}{\text{USE}}$. (**The PRI will flash**)

11. Press . The PRI will stop flashing.

12. Press  until the display reads: $\overset{\text{A2_r}}{\text{USE}}$. If it doesn't, Press the  or  arrow

buttons until the display reads: $\overset{\text{A2_r}}{\text{USE}}$. (**The A2_r will flash**)

13. Press . The A2_r will stop flashing.

14. Press  until the display reads: $\overset{\text{UF}}{\text{inPt}}$.

Turn OFF the machine, WAIT 5 seconds and turn the machine ON.

The **lower** display will read: -328 .

15. Press \square . The display will read: $\begin{matrix} -328 \\ SP \end{matrix}$. Press the \square or \square arrow buttons until the display reads: $\begin{matrix} 80 \\ SP \end{matrix}$.

16. Press \square . The **lower** display will read: 80.

Turn OFF the machine, WAIT 5 seconds and turn the machine ON.

The **lower** display will read: 80.

17. Press \square , hold it and press \square The display will read: $\begin{matrix} 0P\text{t}r \\ S\text{L}\text{C}\text{t} \end{matrix}$.

18. Press \square until the display reads: $\begin{matrix} S\text{E}\text{t}P \\ S\text{L}\text{C}\text{t} \end{matrix}$.



19. Press \square . The display will read: $\begin{matrix} 0 \\ U\text{L}\text{oc} \end{matrix}$.



20. Press the \square or \square arrow buttons until the display reads: $\begin{matrix} 10 \\ U\text{L}\text{oc} \end{matrix}$.

21. Press \square . until the display reads: $\begin{matrix} 25 \\ b\text{,}R5 \end{matrix}$. Press the \square or \square arrow buttons until the display reads: $\begin{matrix} 10 \\ b\text{,}R5 \end{matrix}$.



22. Press \square . until the display reads: $\begin{matrix} 2\text{,}132 \\ SP\text{u}\text{L} \end{matrix}$. Press the \square or \square arrow buttons until the display reads: $\begin{matrix} 475 \\ SP\text{u}\text{L} \end{matrix}$.

23. Press \square . until the display reads: $\begin{matrix} -328 \\ SP\text{L}\text{L} \end{matrix}$. Press the \square or \square arrow buttons until the display reads: $\begin{matrix} 60 \\ SP\text{L}\text{L} \end{matrix}$.

24. Press  until the display reads: $\begin{matrix} 32 \\ \text{Ct} \end{matrix}$. Press the  or  arrow buttons until the display reads: $\begin{matrix} 1 \\ \text{Ct} \end{matrix}$.

25. Press  until the display reads: $\begin{matrix} d.5R \\ \text{RPr} \end{matrix}$. Press the  or  arrow buttons until the display reads: $\begin{matrix} \text{EnRb} \\ \text{RPr} \end{matrix}$.

Turn OFF the machine. Wait 5 seconds and turn on the machine.

26. Press . The display will read: $\begin{matrix} 80 \\ 5P \end{matrix}$. Press the  or  arrow buttons to change the temperature to the required setting.

27. Press  to save the change.

Turn OFF the machine. Wait 5 seconds and turn on the machine.

(if the setup is correct, the “AT” light on the controller will be flashing)

Allow the machine to warm up to operating temp. This completes the controller setup. The machine is now ready to operate.

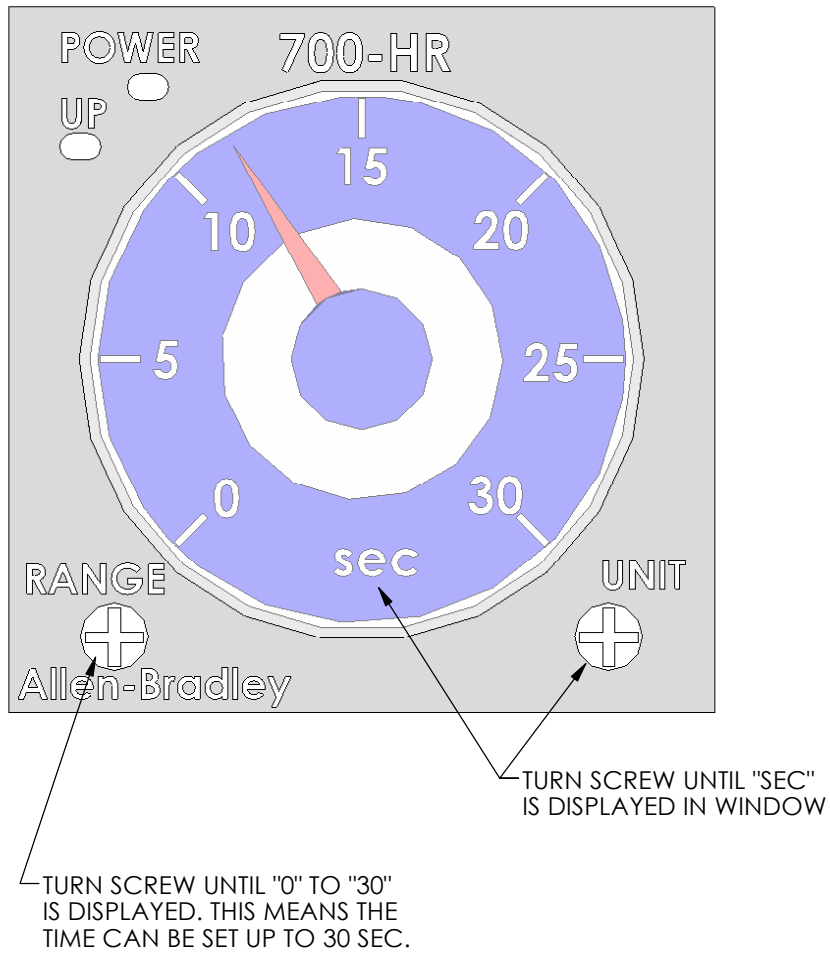

FOLLOW THESE INSTRUCTIONS IF, TENOR TIMER, 2860 IS BEING REPLACED BY ALLEN-BRADLEY TIMER, 70184 OR IF 70184 IS REPLACED WITH SAME.

**SET-UP PROCEDURE FOR REPLACEMENT TIMER, 70184
70187INST**